

ALPINE

ENCYCLOPEDIA OF TRUSSES



A GUIDE TO USING TRUSSES



Since 1966 architects and builders have specified millions of roof and floor trusses engineered by the staff of Alpine Engineered Products, Inc. These trusses, manufactured by truss plants in every state and province, are used in one of every five homes built in the U.S. and Canada today, as well as in many commercial, institutional and agricultural buildings.

Alpine maintains a leadership position in the industry through research, development, technical knowledge and customer oriented service. Our truss manufacturers are supported by more than 30 professional engineers in the U.S. representing all 50 states and the 10 provinces in Canada, and more than one hundred other design and computer technicians.

Alpine's truss design methodology is in accordance with national standards and is backed by extensive research and testing.

Truss manufacturers in the United States, Canada, the United Kingdom, and South Africa depend on Alpine for truss assembly equipment, metal connector plates, truss design service, design software, connectors and anchors, and other truss related products.

© Copyright 2003 Alpine Engineered Products, Inc.

The Encyclopedia of Trusses is intended as a guide to architects, engineers, building designers and contractors for suggested uses of trusses. The building code of jurisdiction and a truss design professional should be consulted before incorporating information from this publication into any structure. The contents herein are for the exclusive use of component manufacturers who use products from Alpine Engineered Products, Inc. in the sale and promotion of trusses.

Alpine Engineered Products, Inc., nor any of its divisions or companies, does not warrant the recommendations and information contained herein as proper under all conditions and expressly disclaims any responsibility for damages arising from the use, application, or reliance on the recommendations contained herein.





Benefits of Framing With Trusses:
 For Architects and Contractors 2
 For Owners. 3

Ordering Trusses:
 Building Code of Jurisdiction 4
 Building Use. 4
 Geometry 4
 Bearings 5
 Spacing. 5
 Design Loads 5
 Special Conditions. 5
 Take-Off And Estimating 6

Building Designer's Reference Section: . . . 7
 Truss Configurations 8
 Framing With Wood Trusses: Roofs . . 10
 Framing With Wood Trusses: Floor . . 16
 Drainage. 19
 Snow Drifting. 20
 Wind Loading. 21
 Fire Resistance Ratings 22
 Sound Transmission. 23
 Suggested Specifications 24
 Typical Design Drawing 27

Builder's and Contractor's Section: 28
 Responsibility 28
 Handling 29
 Installing 30
 Bracing. 31
 Bracing Design. 35

Construction Loads 36
Construction Hardware. 37
TrusSteel- Light Gauge Steel Trusses 38
About the Industry and Its Products 42
Information Sources. 43
 Design Considerations 44

Appendices:
 A - Weight Of Material. 45
 B - References. 46
 C - Glossary 47
 Truss Production Sequence 48





Special Benefits for Architects and Engineers

- Using Alpine's proprietary software, truss designers can produce engineered shapes that satisfy virtually any aesthetic and functional specification by the building design professional.
- Trusses offer simple solutions to complex designs and unusual conditions without inhibiting building design freedom.
- Nationally recognized standards for truss design and manufacturing of metal plate connected wood trusses have been adopted by major model building codes. This ensures a quality product.
- Truss manufacturers that use Alpine software are available for consultation when special framing situations arise.
- Alpine professional engineers are committed to providing the highest quality, cost efficient structural products for your clients.
- Wood trusses connected with Alpine metal plates enjoy an outstanding record of more than 35 years of proven performance and durability.



Special Benefits for Contractors

- The use of preassembled components generates less waste at the jobsite. This improves safety and reduces cleanup costs.
- Trusses are built in a computer-aided manufacturing environment to assure accuracy and quality.
- Industry standards for manufacturing and handling assure code-compliance.
- Trusses are lightweight and easy to install, requiring only normal construction tools.
- The wide nailing surface of 4x2 floor trusses safely speeds deck and flooring installation.
- Expenses are accurately controlled because truss costs can be predetermined. On-site losses from miscutting, theft and damage are virtually eliminated.
- Open web design allows easy installation of plumbing, electrical wiring and heating/cooling duct work.
- Trusses are available locally for fast delivery. More than 550 truss manufacturers throughout the United States and Canada are backed by the expertise of Alpine Engineered Products, Inc.





Special Benefits for the Owner

- The owner can enjoy peace of mind, knowing that the trusses have been professionally engineered and quality manufactured for the specific job.
- The resiliency of wood provides a floor system that is comfortable.
- Wood is a natural insulator because it is composed of thousands of individual cells, making it a poor conductor of heat and cold.
- Roof truss details such as tray, vaulted or studio ceilings improve the appearance and comfort of homes, offices, churches and commercial buildings.
- Floor trusses can conceal mechanical services, leaving a clear plane for ceiling installations. This is ideal for finished rooms in a lower level.
- Trusses provide clear spans so interior walls can be moved easily during remodeling or when making additions.





Checklist of Information Needed by Truss Manufacturers to Design and Manufacture an Order of Trusses

- Building Code of Jurisdiction
- Building use
- Geometry
- Location and size of all points of bearing
- Center-to-center spacing of trusses
- Design loads
 - Uniform live and dead loads
 - Concentrated loads such as mechanical equipment or sprinklers
 - Special load cases
 - Environmental loads (wind, snow and seismic)
- Special conditions
 - Corrosive environments, etc.

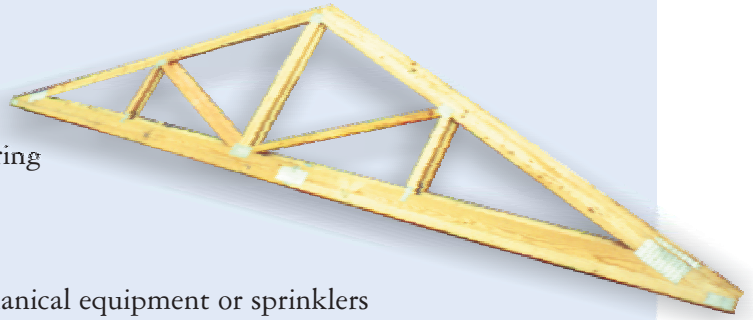

A discussion of each item follows:

Building Code of Jurisdiction

Generally, local building codes are based on one of the national model codes. However, many local jurisdictions have variances that can have an impact on truss design. It is therefore important that the truss designer be informed of all codes of jurisdiction. The model codes referred to are: The IBC *International Building Code* and the IRC *International Residential Code*, published by the International Code Council (ICC), the BOCA *National Building Code*,

published by the Building Officials Conference of America International (BOCA); the *Uniform Building Code*, published by the International Conference of Building Officials (ICBO); and the *Standard Building Code*, published by the Southern Building Code Congress International (SBCCI) and in Canada, the *National Building Code of Canada* (NBCC) as adopted by the various Provincial Authorities.

Building Use

Building regulations differ for various types of use and occupancy. Specify classification of use, such as single family residential, multi-family residential, offices, retail, manufacturing,

churches, institutional (long-term care, nursing homes, schools, hospitals, jails, etc.) or agricultural (non-human occupancy).

Geometry

Furnish span (out-to-out of bearings, plus cantilevers, if any), slope, overhang conditions, etc., that form the profiles or external geometry of the trusses. Web configuration need not be

furnished, as it is determined by the overall truss design. Also furnish any minimum lumber size requirements.

Bearings

Specify all exterior and interior points of bearing, showing location by dimension and size. Reaction forces at point of bearing may

affect the required size of bearing surface to prevent crushing.

Spacing

Give center-to-center spacing of trusses. If trusses are spaced greater than 24 inches center-to-

center, it is necessary to indicate the purlin spacing and method of attachment to the trusses.

Design (Specified) Loads

Truss design (specified) loads include both live and dead loads which may be uniformly distributed or may be concentrated at various locations.

LIVE LOADS: Live loads are non-permanent loads. Environmental loads produced by snow, wind, rain, or seismic forces are live loads. The weight of temporary construction materials and occupant floor loads are live loads. Live loads are usually uniform in their application and are set by building codes or building designer. Live loads will vary by location and use and should be furnished in pounds-per-square-foot, or other

clearly defined format.

DEAD LOADS: Dead loads are the weight of the materials in the structure and any items permanently placed on the structure.

SPECIAL LOADS: Special loads can be live or dead. Examples of special loads might include mechanical units, poultry cages, cranes, sprinkler systems, moveable partition walls, etc. The weight, location and method of attachment must be provided to the truss designer. Multiple load cases may be required in truss design.

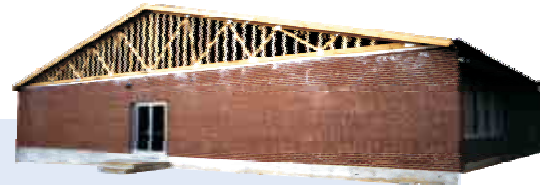

Special Conditions

Some of the special conditions that are important to truss design include:

- 1) Jobsite conditions that may cause rough handling of the trusses.
- 2) High moisture or temperature conditions.
- 3) Use of trusses to transfer wind loads.
- 4) Fire resistance requirements.
- 5) Higher adjacent roofs that may discharge snow onto lower roofs.

6) Location from coastline, exposure and height above ground for wind.

7) Parapets, signage or other obstructions that may cause snow drifting, or prevent the free runoff of water from the roof.

8) Any other condition that affects the load carrying ability of the roof or floor framing.

9) Floor trusses, office loads or ceramic tiles require special considerations during the building and truss design process.

Lack of information about any of these conditions could adversely affect the performance of the trusses.

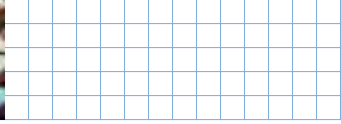

To Figure Truss Requirements	Calculations	Truss Order
<p>1 Determine the part of the larger rectangle requiring common trusses (distance from peak point to peak point) by subtracting the width or span from the length</p>	<p>$48'-0" - 24'-0" = 24'-0"$ Distance requiring Standard Trusses.</p>	<p>FOR LARGE RECTANGLE</p> <p>5 Standard 24'-0" trusses overhang on both ends.</p>
<p>2 Divide this distance by 2 (trusses are set 24" on center) and subtract one truss.</p>	<p>$24'-0" \div 2 = 12$ Trusses. $12 - 1 = 11$.</p>	<p>6 Standard 24'-0" Trusses clipped on one end.</p>
<p>3 Add the number of Hip Ends required.</p>	<p>2 Hip Ends.</p>	<p>1 Terminal Hip Set 24'-0" overhang both ends. 1 Terminal Hip Set 24'-0" overhang one end.</p>
<p>4 No overhang on trusses to be carried by the girder.</p>		<p>FOR SMALLER RECTANGLE</p> <p>1 Girder 24'-0" Span.</p>
<p>5 Determine the Multi-Ply Girder.</p>	<p>24'-0" Span Girder carrying 24'-0" Span Trusses.</p>	<p>1 Terminal Hip Set, 24'-0" span, overhang on both ends.</p>
<p>6 Add one Hip End for the Projection.</p>	<p>1 Hip End.</p>	<p>1 Set of 5 Valley Frames.</p>
<p>7 Determine the number of Valley Frames.</p>	<p>Valleys for 24'-0" Span.</p>	

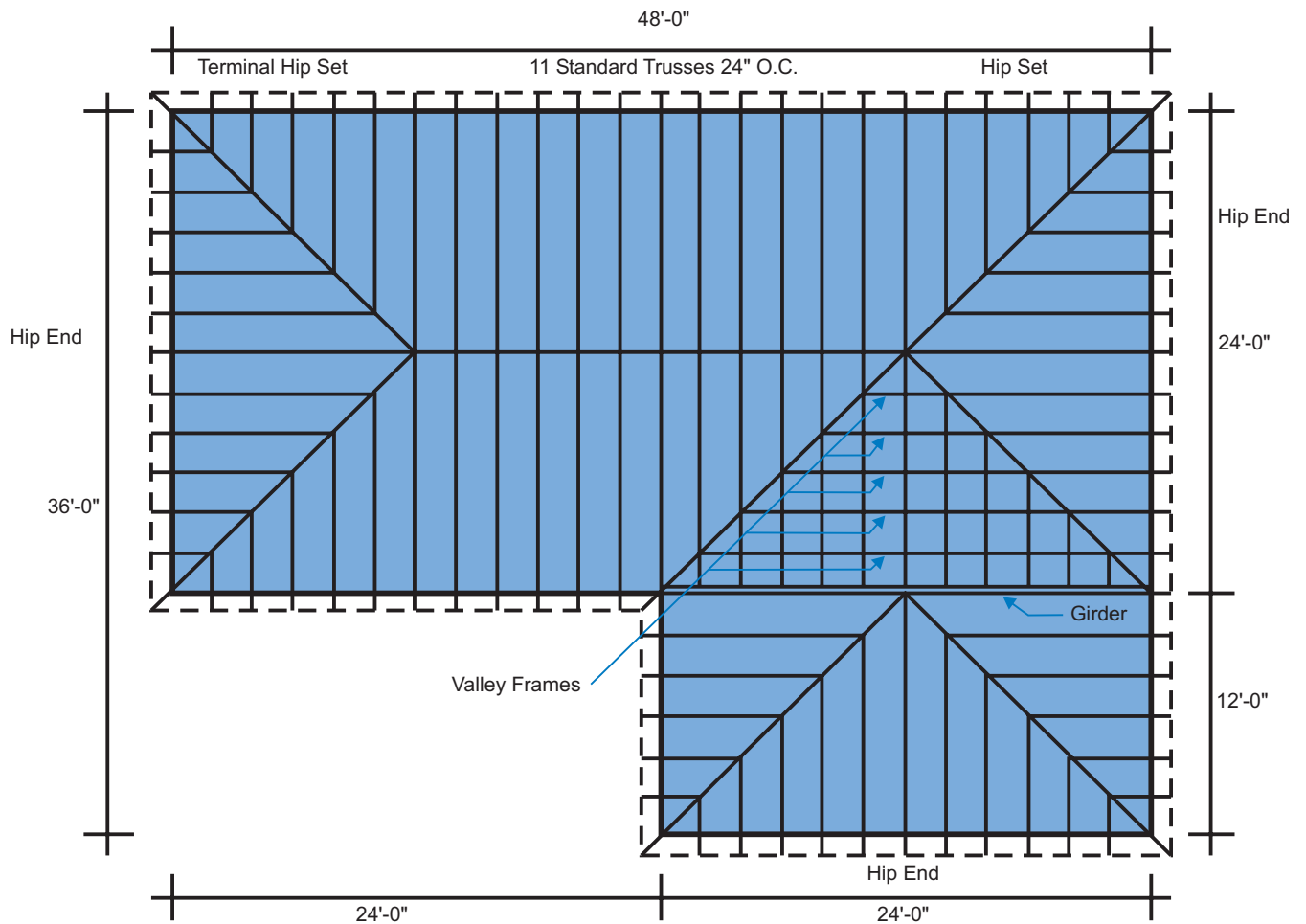

Framing With Roof Trusses



Framing With Floor Trusses



Truss Configurations

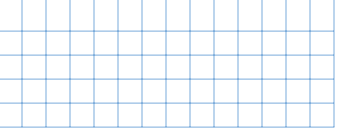

Wood trusses are pre-built components that function as structural support members. A truss commonly employs one or more triangles in its construction. The wood truss configurations illustrated here are a representative sampling.

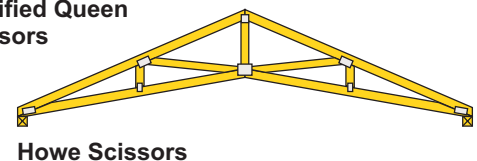
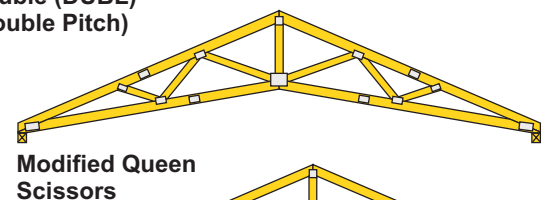
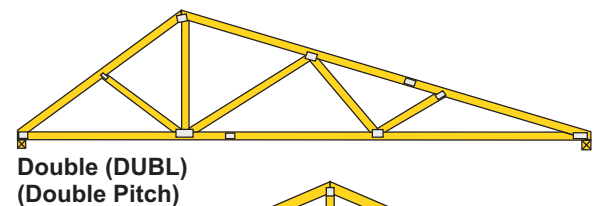
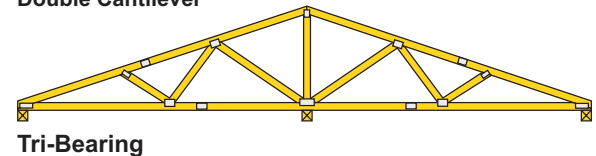
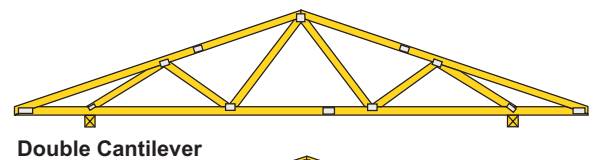
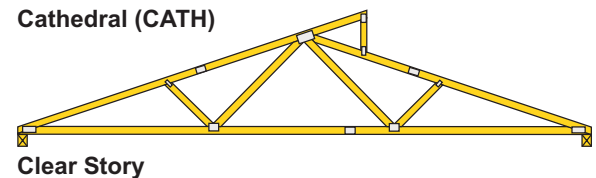
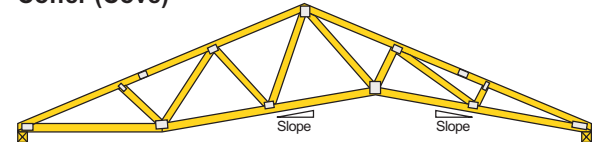
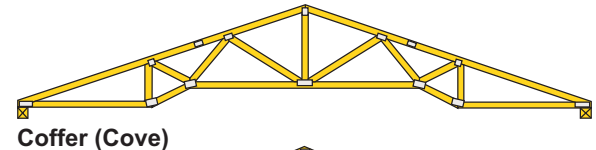
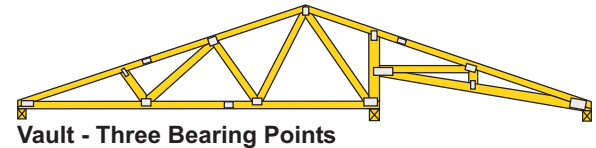
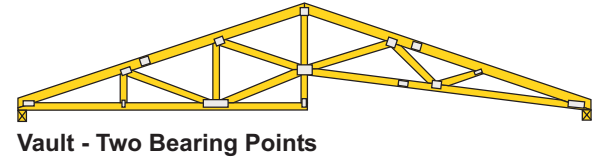
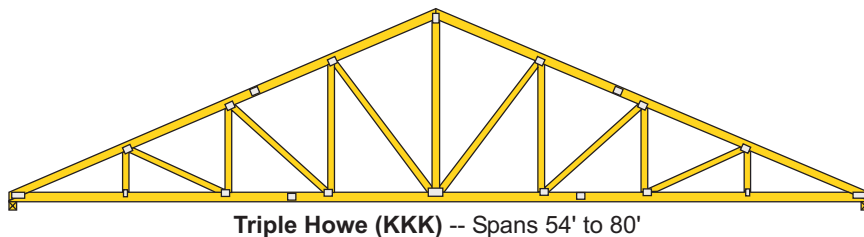
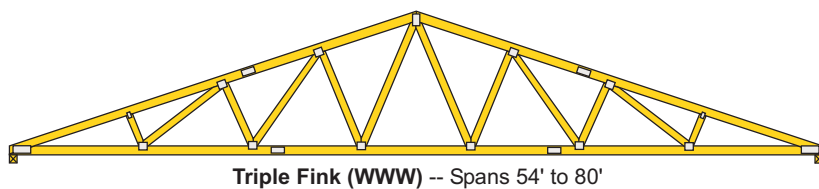
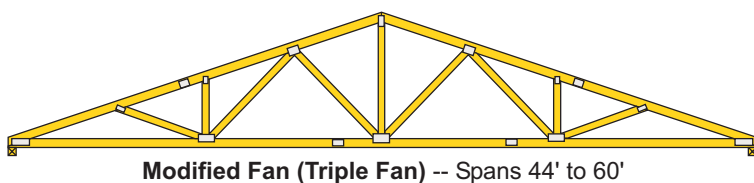
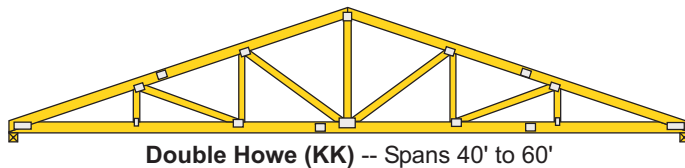
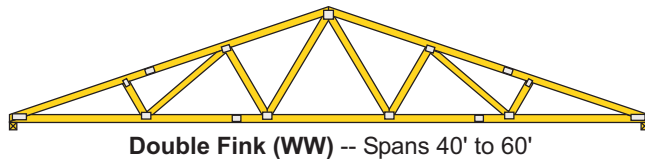
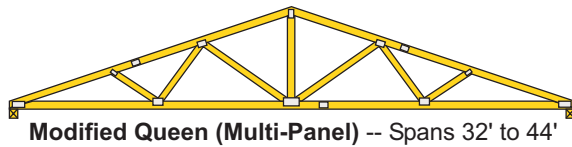
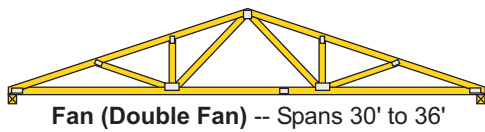
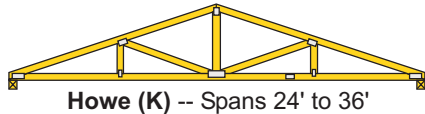
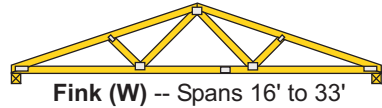
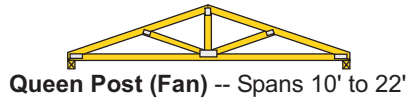

Truss Configurations

The number of panels, configuration of webs and allowable length of spans will vary according to given applications, building materials and regional conditions. Always refer to an engineered drawing for the actual truss design.

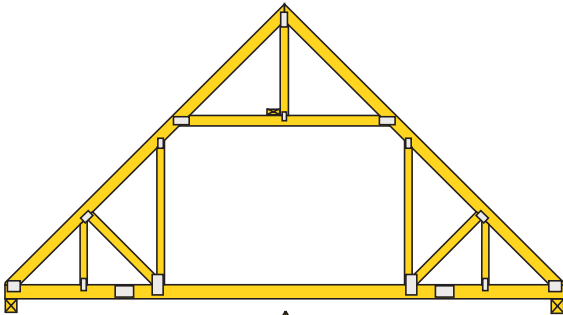

Room-In-Attic

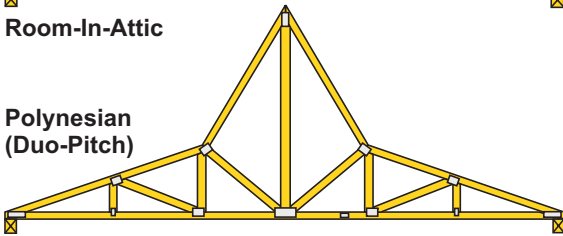

Polynesian (Duo-Pitch)

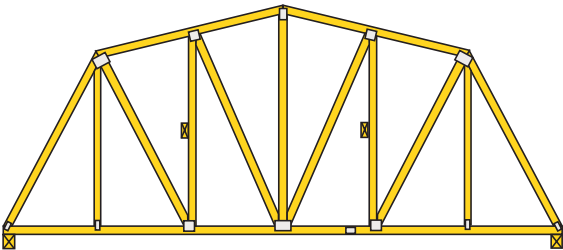

Gambrel

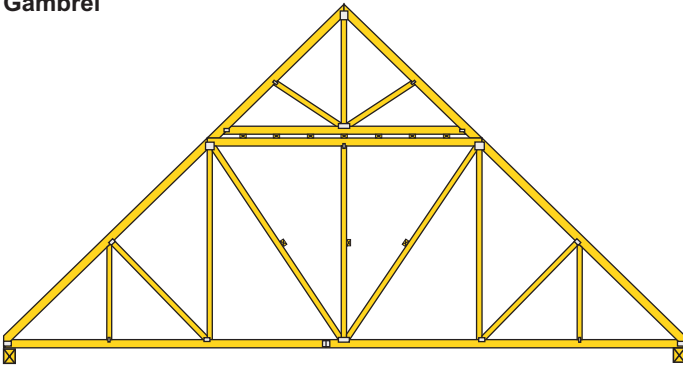

Piggyback

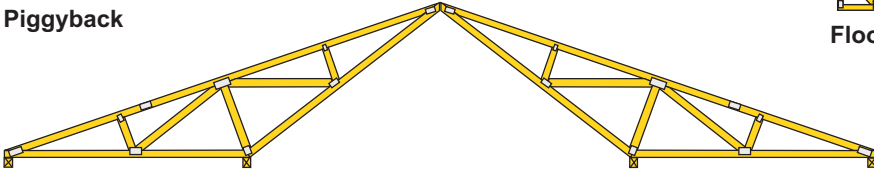

Double Inverted -- Lengths 50' to 80'

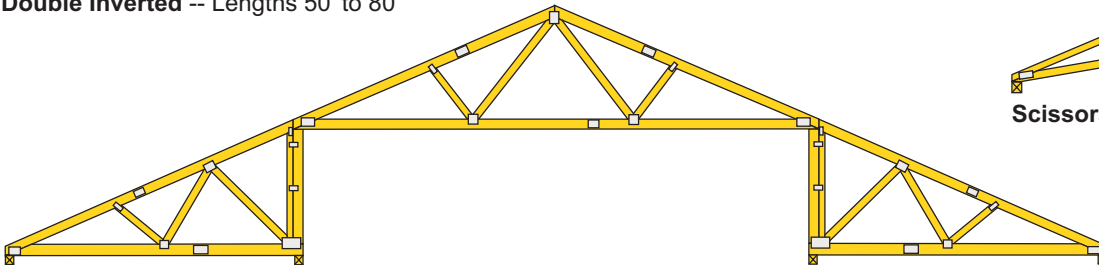

Three Piece Raised Center Bay -- Lengths 50' to 100'+

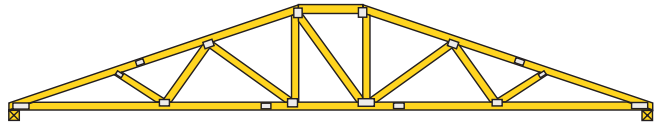

Stepdown Hip

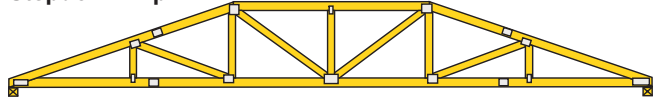

Hip Girder

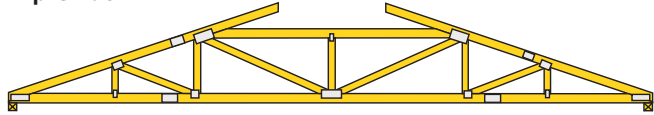

California Hip

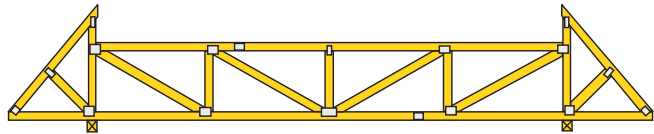

Double Cantilever With Parapets

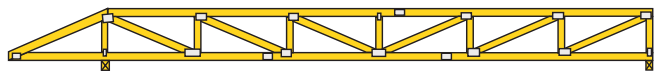

Flat Truss With Cantilever (Pratt Configuration)

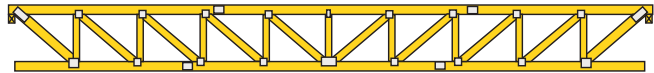

Top Chord Bearing Flat Truss (Pratt Configuration)

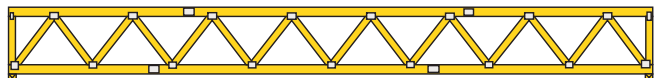

Flat Truss (Warren Configuration)

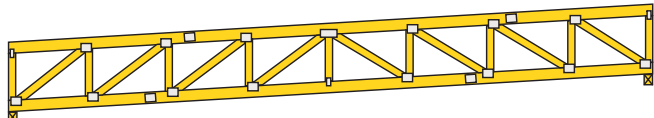

Sloping Parallel Chords (Howe Configuration)

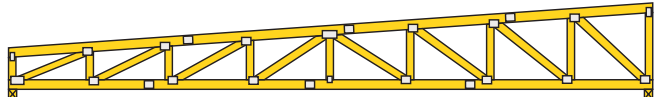

Sloping Top Chord (Howe Configuration)



Floor Truss (System 42 - Modified Warren Configuration)

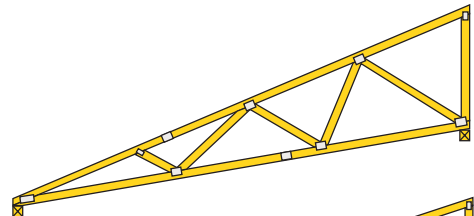

Scissors Mono

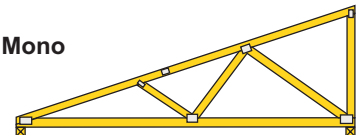

Mono

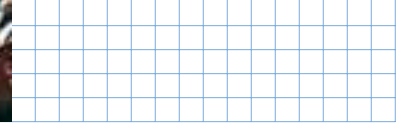

Hip Framing

Trussed hip framing offers the advantage of clear span, an eave or fascia line at the same elevation around the building, and the speed of pre-built components. The end slope may be equal to or different from the side slope. The ceiling line may be flat or sloped. Sloped ceilings have limitations, therefore, consult the truss designer.

Terminal Hip Framing

Best suited for relatively short spans of 26'-0" or less, the hip jacks extend directly to the peak. The distance from the end wall to the face of the girder is equal to one half the span, provided the slopes are equal. The last standard truss is designed as a girder to carry the loads transferred by the hip jack.

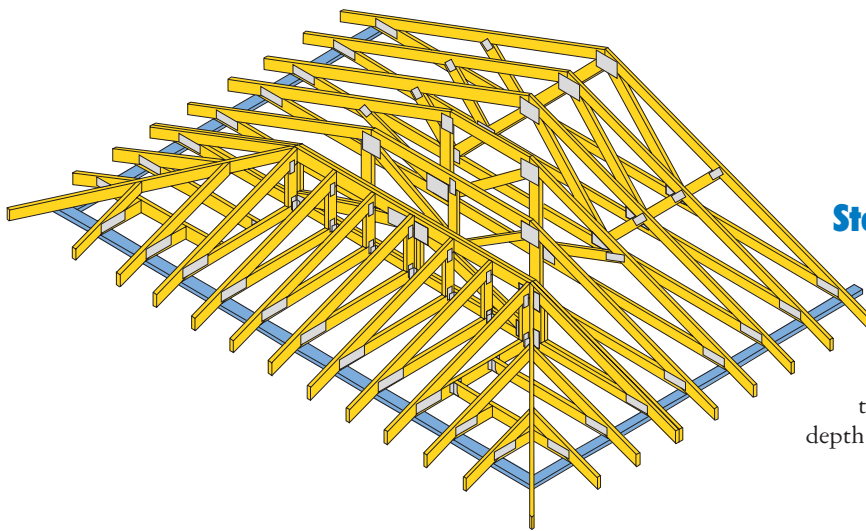
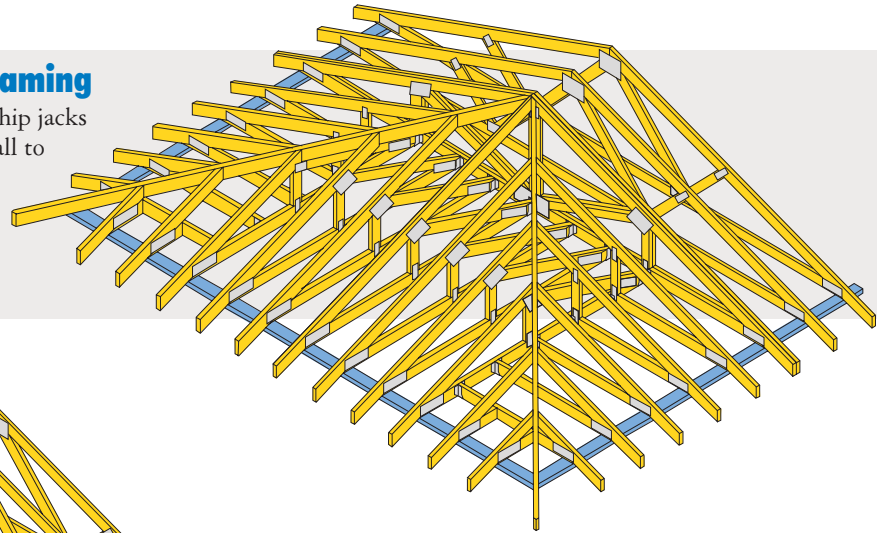

Step Down Hip Framing

Better suited for longer spans, the Step Down hip is the most versatile of all hip types. Each of the "step down" trusses is the same span and has the same overhang as the adjacent standard trusses, but decrease in height to form the end slope. The girder location is generally from 8 to 12 feet from the end wall and is determined by the span to depth ratio. The corner and end jacks are normally pre-built.

Midwest Hip Framing

The Midwest type hip framing was developed to create a more uniform configuration of each of the trusses in the hip. This hip type also provides for a more uniform structure for attaching the decking. Span capability is the same as the step down hip.

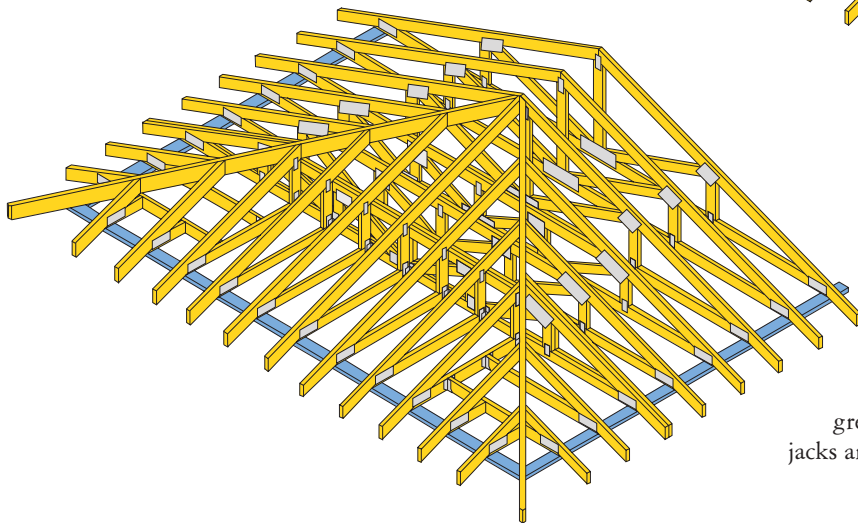
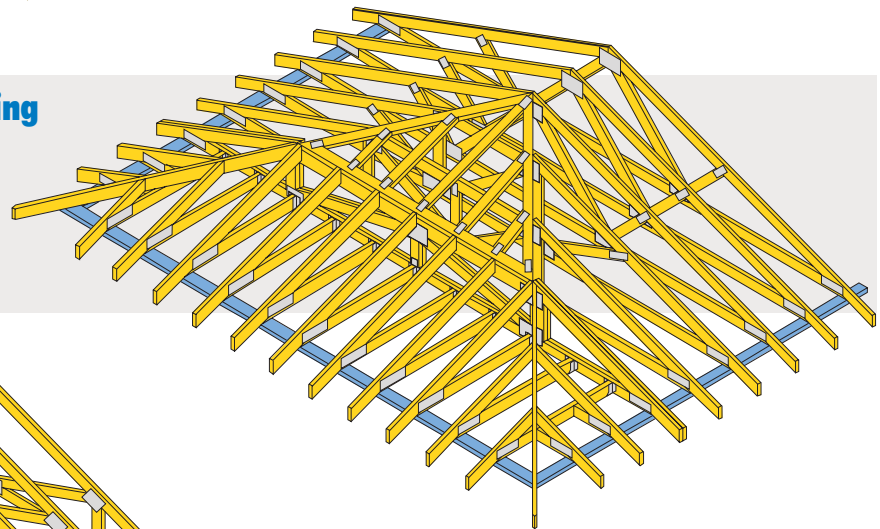

California Hip Framing

Although this type hip framing is used as an alternative to the step down hip, the California hip is similar in span capability and field installation. The base portion of each truss inside the girder is the same, except that the sloping top chord of each successive truss is extended upward greater amounts to form the slope intersection. Corner and end jacks are used to form the area outside the girder.

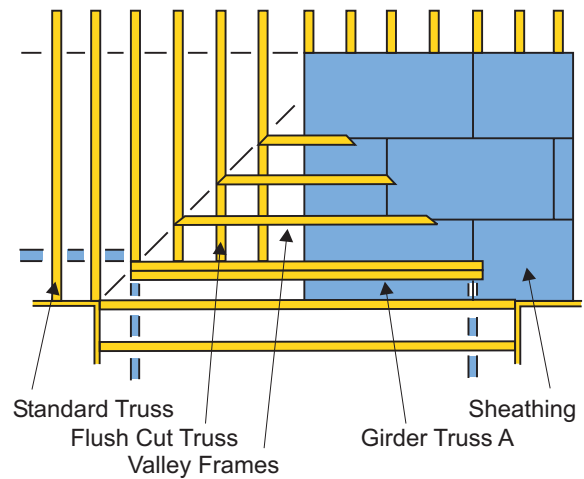
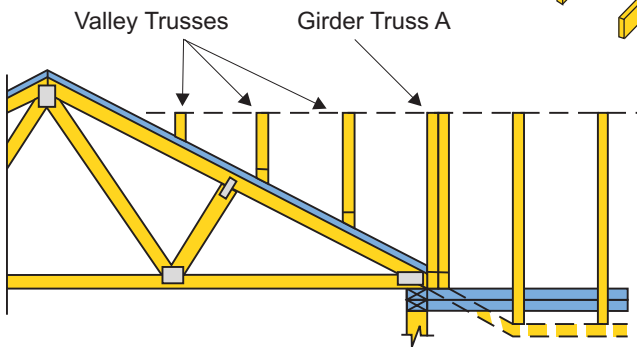
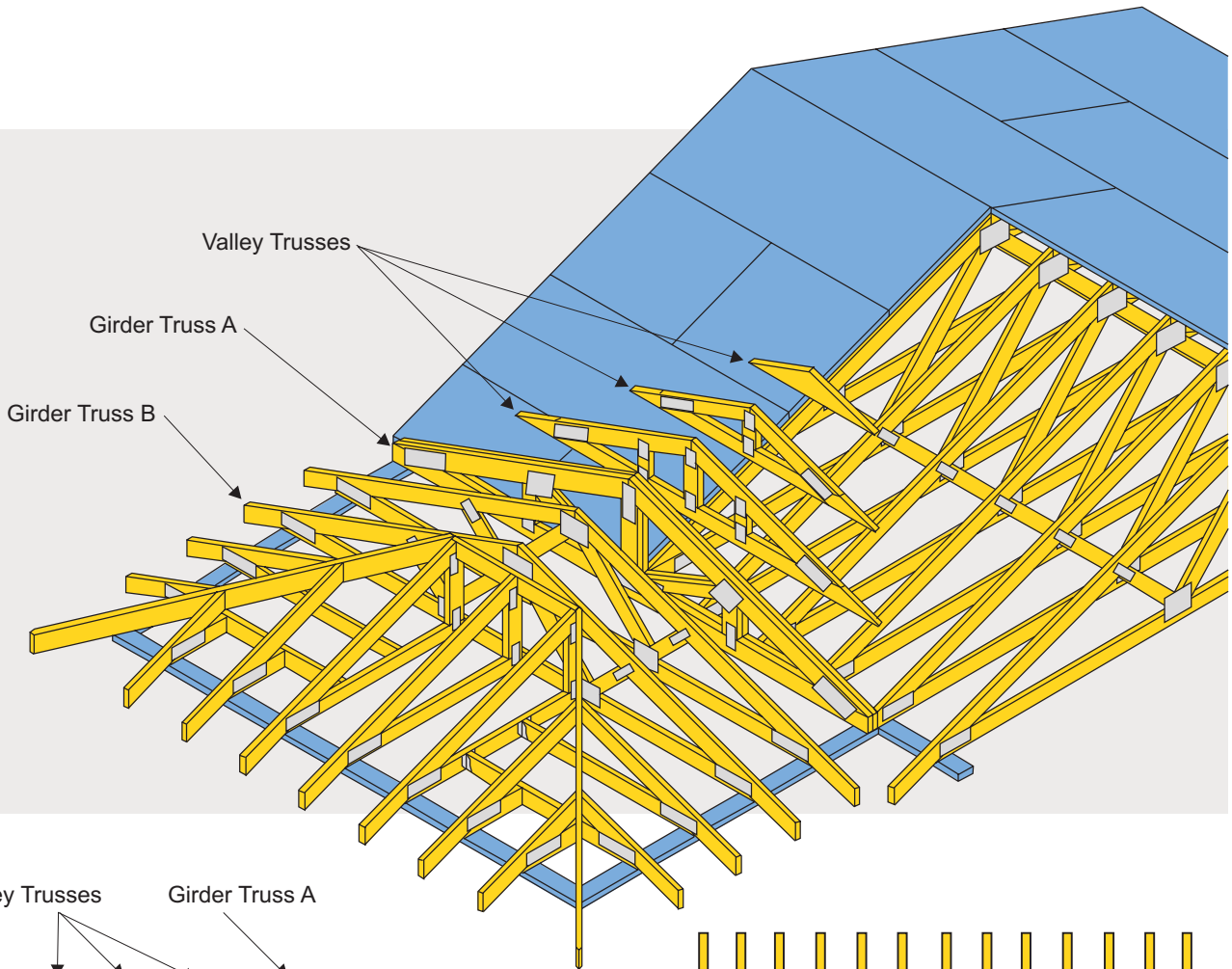

Girder Trusses

Girder trusses have two main purposes. The first (Girder Truss A) exists in L, T, H and U shaped buildings to eliminate the need for an interior load-bearing wall. The girder is used to support one end of the intersecting trusses. The trusses are carried on the bottom chord of the girder by hangers.

The second use of a girder truss (Girder Truss B) is to support perpendicular framing in hip roofs. In some plans girder truss A and B may be one in the same. The hip framing is carried on both the top and bottom chords of the girder truss by nailing or by hangers.

Girder trusses, because of the heavy loads they support, are generally multiple units with larger chord members than the adjacent trusses. Generally, because of the construction of girders, overhangs are not used.

The girder truss may also be designed for “drag strut” loads which are calculated and specified by the building designer.

Valley Framing Sets

Valley framing sets are primarily used to form a ridge line by framing over the main roof where perpendicular building sections intersect.

Valley trusses are set directly on the main trusses.

Sheathing is required for main trusses with 2x4 top chords, and is recommended for other top chord sizes, under valley frames to continue the lateral bracing of the main truss top chords. The bottom chords of the valley trusses are generally beveled to match the slope of the roof below.

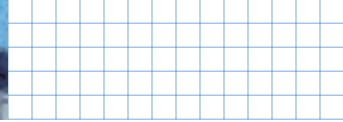

Gable Framing

Gable ends when not configured in triangles as a truss, are more related to stud walls. However, they are structural elements and are analyzed to resist wind and seismic loads as noted on the truss design. The web design or framing pattern is determined by the

type of siding, either horizontal or vertical, and the need for a louver in the end of the building. The type of gable required is controlled by the end overhang and the need to match a soffit line.

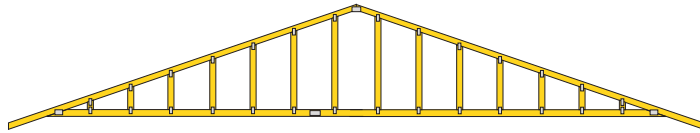

Standard Gable

Stud spacing as necessary to support siding.

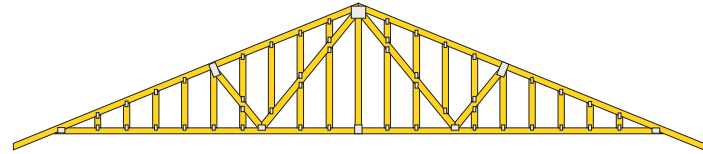

Clearspan Gable

Used when the gable wall does not provide continuous bearing support for the gable framing.

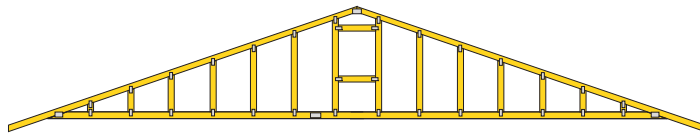

Standard Gable Framed For Rectangular Louver

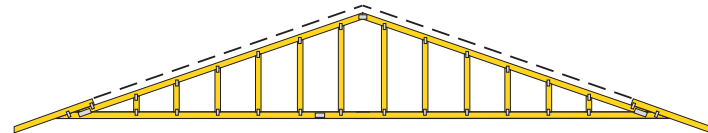

Dropped Top Chord Gable

Illustrated with studs. Also available with framing for rectangular, square or triangular louver.

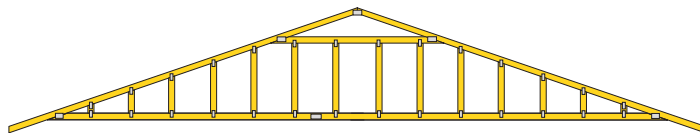

Standard Gable Framed For Triangular Louver

Drop Top Chord Gable

Standard Truss

Rafter

Standard Gable

2x4 Ladder Frame (Outlooker)

Gable End

2x4 Block

2-16d @ 24" O.C.

Truss

Standard Truss

Rafter

2x4 Ladder Frame (Outlooker)

2-16d @ 24" O.C.

Gable End

Truss

2x Block

8" Typical

A reinforcing member may be required on some gable end vertical members.

Panel Framing For Flat Roofs

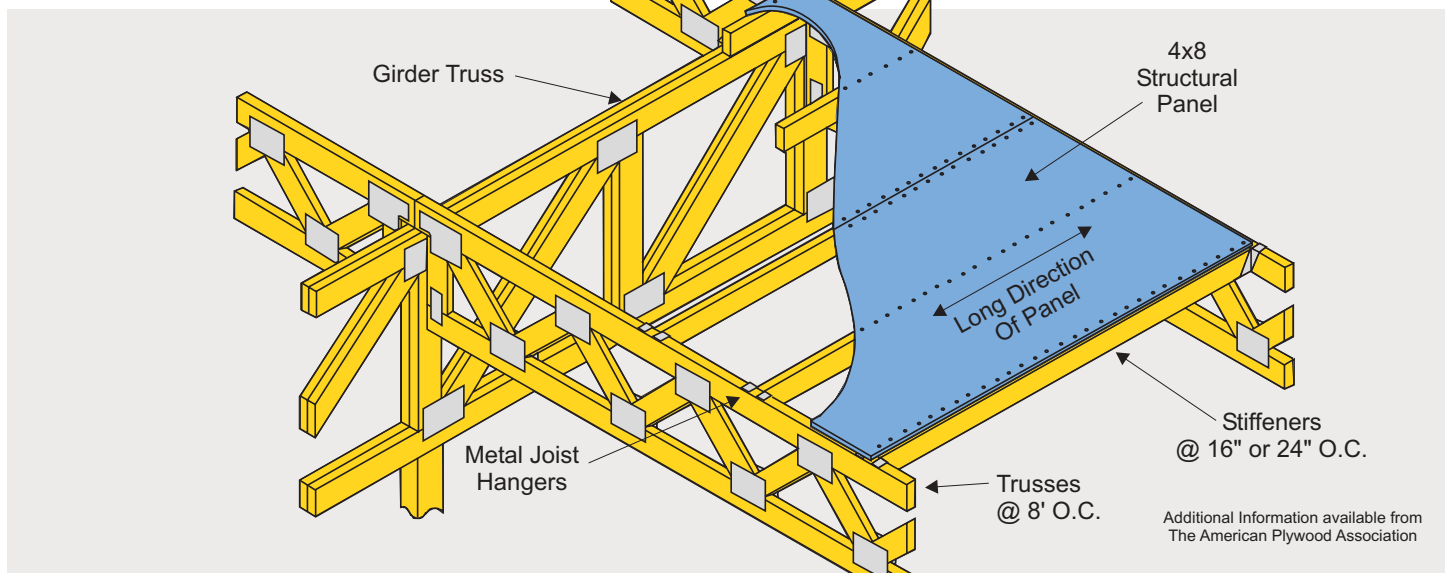

Typical Sloped Flat Truss End Conditions

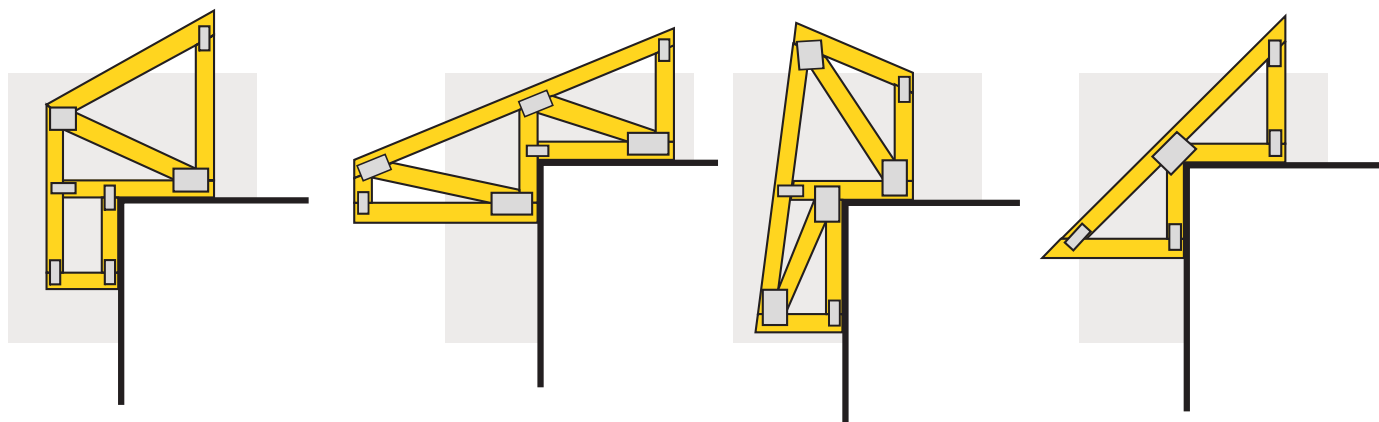
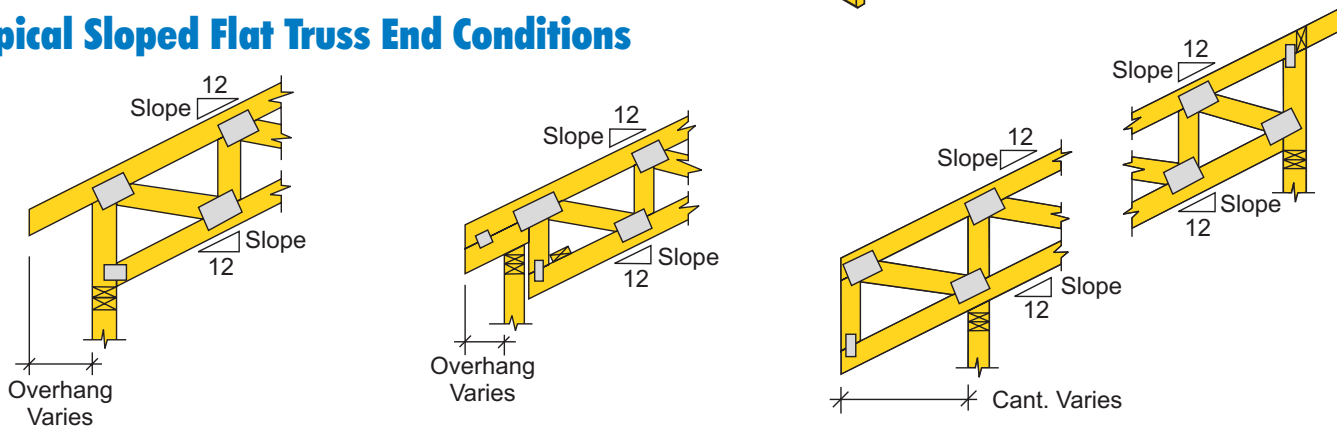

Mansard Frames

Mansard details are normally built onto the truss. However, there are design situations where it is more appropriate to have the mansard frame installed independent of the roof framing. Those occasions might be when the use of the building dictates a

construction type requiring masonry exterior walls and a non-combustible roof, difficult erection and handling situations or remodeling. Building codes may require special load cases.



Cantilevers and Overhangs

Cantilever conditions are common in truss designs. A cantilever exists when the bearing wall occurs inside of the truss overall length, excluding overhangs, such as to form a porch or entrance way.

When the bearing is located under the scarf line of the truss, no heel joint modification is needed. Wedge blocks or sliders (reinforcing members) are used to stiffen the heel panel when the bearing is moved inside the scarf line. Wedge blocks act to stiffen the heel joint and are connected to the top and bottom chord with connector plates located over or just inside the bearing. Sliders allow longer cantilevers by stiffening the top and bottom chords in the heel panel. Correct plating of sliders varies from normal heel joints.

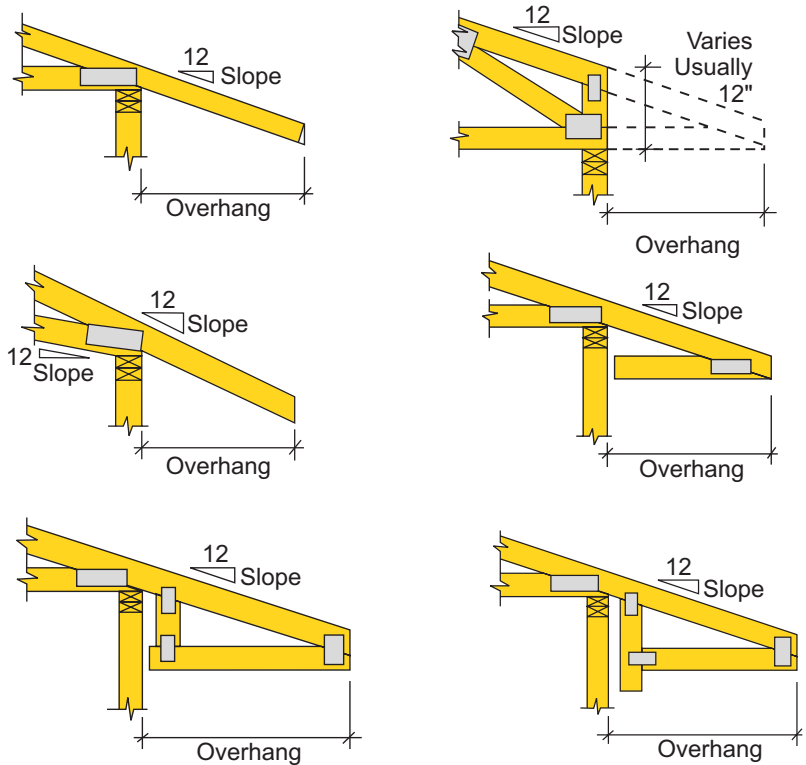

Typical Methods Used In Cantilever Conditions

Exact Method Subject To Final Truss Design

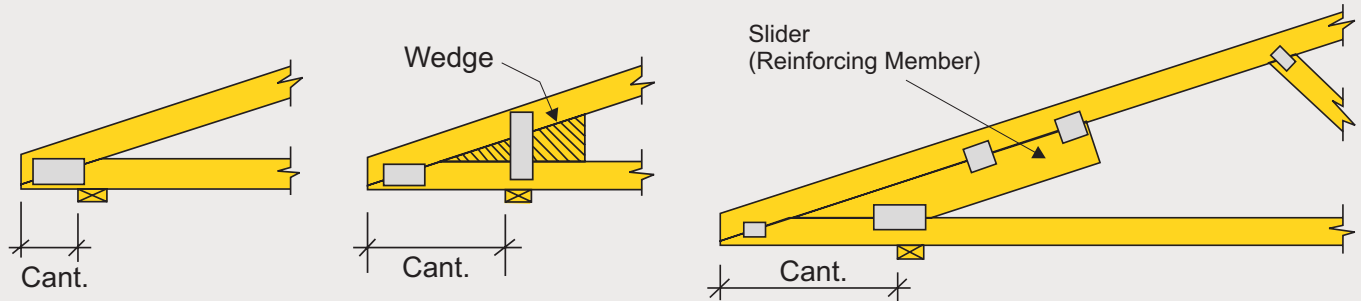

Long Cantilevers

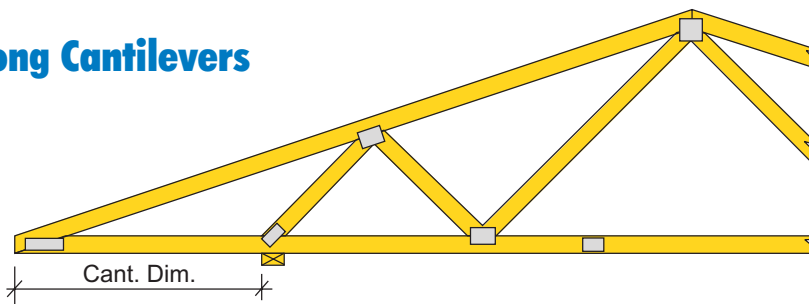

The additional web (strut) is added when the cantilever distance is too long for use with the wedge block or reinforcing member. This member often requires continuous lateral bracing (CLB).

Cantilever End Details For Flat Roofs

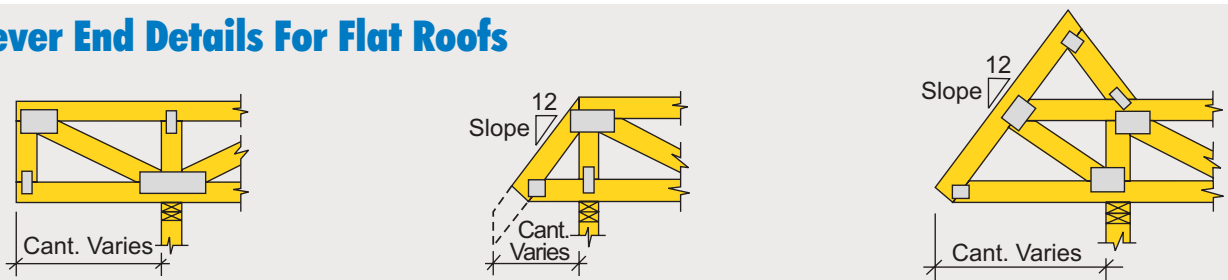

Roof Truss Span Tables

Alpine truss designs are engineered to meet specific span, configuration and load conditions. The shapes and spans shown here represent only a fraction of the millions of designs produced by Alpine engineers.

Total load(PSF) Duration factor Live load(PSF) Roof type	55 1.15 40 snow shingle			47 1.15 30 snow shingle			40 1.15 20 snow shingle			40 1.25 20** shingle		
Top Chord	2x4	2x6	2x6	2x4	2x6	2x6	2x4	2x6	2x6	2x4	2x6	2x6
Bottom Chord	2x4	2x4	2x6	2x4	2x4	2x6	2x4	2x4	2x6	2x4	2x4	2x6

**construction or rain, not snow load

Common -- Truss configurations for the most widely designed roof shapes.

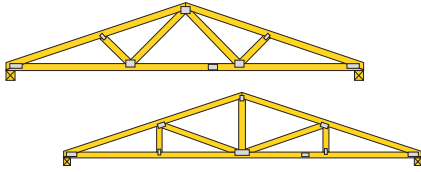

Pitch	Spans in feet to out of bearing											
2/12	24	24	33	27	27	37	31	31	43	33	33	46
2.5/12	29	29	39	33	33	45	37	38	52	39	40	55
3/12	34	34	46	37	39	53	40	44	60	43	46	64
3.5/12	39	39	53	41	44	61	44	50	65	47	52	70
4/12	41	43	59	43	49	64	46	56	69	49	57	74
5/12	44	52	67*	46	58	69*	49	66	74*	53	66	80*
6/12	46	60*	69*	47	67*	71*	51	74*	76*	55	74*	82*
7/12	47	67*	70*	48*	72*	72*	52*	77*	77*	56*	80*	83*

Mono -- Used where the roof is required to slope only in one direction. Also in pairs with their high ends abutting on extremely long spans with a support underneath the high end.

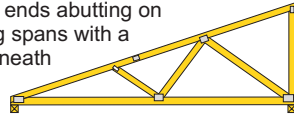

2/12	24	24	33	25	27	38	27	31	41	29	32	44
2.5/12	28	29	40	29	32	43	31	37	46	33	37	49
3/12	30	33	45	31	37	47	34	42	50	36	42	54
3.5/12	33	37	49*	34	41	51*	36	46	54*	39	46	58*
4/12	35	41	52*	36	45*	54*	39	50*	58*	42*	49*	62*
5/12	38*	47*	57*	39*	51*	59*	42*	56*	63*	45*	54*	68*

Scissors -- Provides a cathedral or vaulted ceiling. Most economical when the difference in slope between the top and bottom chords is at least 3/12 or the bottom chord pitch is no more than half the top chord pitch.

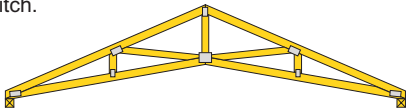

6/12 - 2/12 ‡	40	43	59*	42	49	62*	45	56*	66	48	57*	71*
6/12 - 2.5/12 ‡	37	38	52	38	44	57*	41	50	61*	44	52	66*
6/12 - 3/12 ‡	33	33	45	35	38	52	38	43	56*	40	46	60*
6/12 - 3.5/12 ‡	28	28	38	32	32	44	34	37	50	36	39	54
6/12 - 4/12 ‡	22	22	31	26	26	36	30	30	41	32	32	44

‡ Other pitch combinations available with these spans
For Example, a 5/12 - 2/12 combination has approx. the same allowable span as a 6/12 - 3/12

Flat -- The most economical flat truss for a roof is provided when the depth of the truss in inches is approximately equal to 7% of the span in inches.

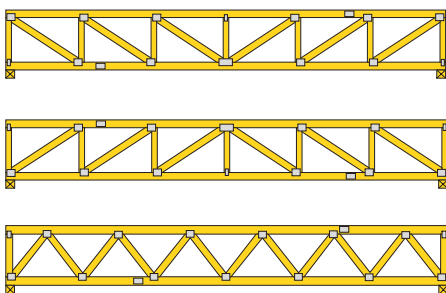

Total load(PSF) Duration factor Live load(PSF)	55 1.15 40 snow			47 1.15 30 snow			40 1.15 20 snow			40 1.25 20 rain or constr.		
Top Chord	2x4	2x6	2x6	2x4	2x6	2x6	2x4	2x6	2x6	2x4	2x6	2x6
Bottom Chord	2x4	2x4	2x6	2x4	2x4	2x6	2x4	2x4	2x6	2x4	2x4	2x6

Depth	Spans in feet to out of bearing											
16"	23	24	25 §	25 §	25 §	25 §	25 §	25 §	25 §	25 §	25 §	25 §
18"	25	27	28	27	27	29 §	29 §	29 §	29 §	29 §	29 §	29 §
20"	27	28	30	28	28	32	31	30	33 §	32	31	33 §
24"	29	30	33	31	31	35	34	33	38	35	34	40
28"	32	32	36	34	33	39	37	36	42	38	37	44
30"	33	33	38	35	35	40	38	37	44	40	39	45
32"	34	34	39	36	36	42	39	39	45	41	40	47
36"	36	36	42	39	38	45	42	41	48	43	43	50
42"	39	39	45	41	41	48	44	44	52	45	46	54
48"	40	42	49	43	44	52	46	47	56	46	49	58
60"	44	47	55	46	49	58	48	53	63	49	55	65
72"	45	51	60	48	54	64	51	57	68	51	59	69

§ = Span Limited by length to depth ratio of 24

NOTES: These overall spans are based on NDS '01 with 4" nominal bearing each end, 24" o.c. spacing, a live load deflection limited to L/240 maximum and use lumber properties as follows: 2x4 f_b=2000 psi f_t=1100 psi E=1.8x10⁶ 2x6 f_b=1750 psi f_t=950 psi f_c=1900 psi E=1.8x10⁶. Allowable

spans for 2x4 top chord trusses using sheathing other than plywood (e.g. spaced sheathing or 1x boards) may be reduced slightly. Trusses must be designed for any special loading such as concentrated loads from hanging partitions or air conditioning units, and snow loads caused by

drifting near parapet or slide-off from higher roofs. To achieve maximum indicated spans, trusses may require six or more panels. Trusses with an asterisk (*) that exceed 14' in height may be shipped in two pieces. Contact your local Alpine truss manufacturer or office for more information.

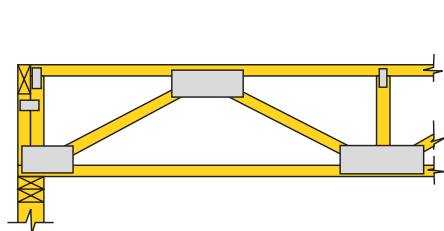

Bottom chord bearing on a stud wall.

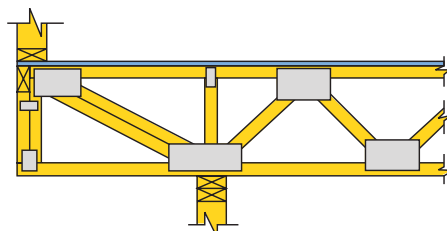

Cantilever with an exterior wall on the end.

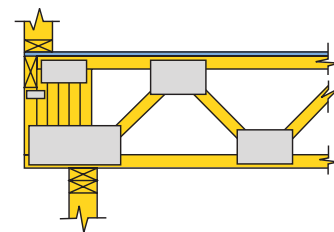

Bottom chord bearing with short cantilever and exterior wall.

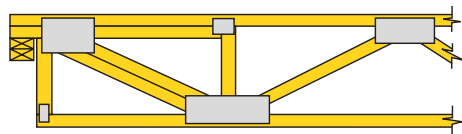

Top chord bearing on stud wall.

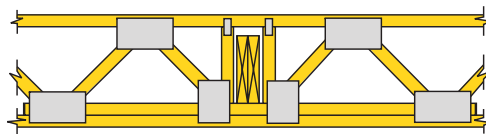

Floor truss designed to carry an interior header.

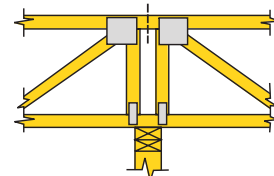

Interior bearing on wall

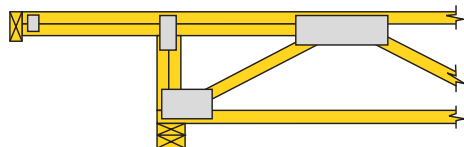

Overhang on a floor truss used on a roof.

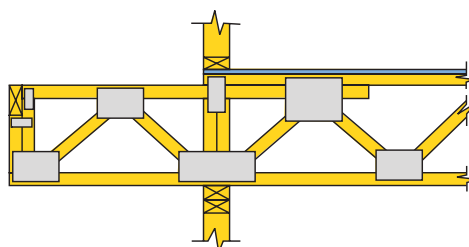

Dropped cantilever for use on exterior balconies.

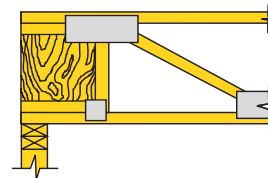

Trimmable end condition with I-Joist insert.

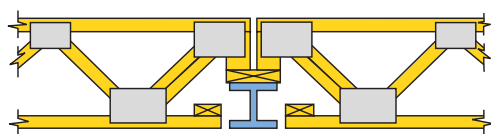

Interior top chord bearing with a variable end height.

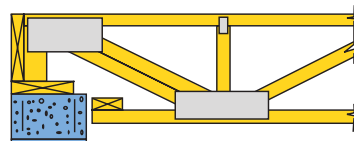

Top chord bearing with a variable end height.

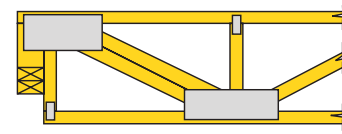

Top chord bearing on stud wall with variable end height.

Multiple ply floor trusses may require special connection details between plies. Special connectors will be specified on the design.

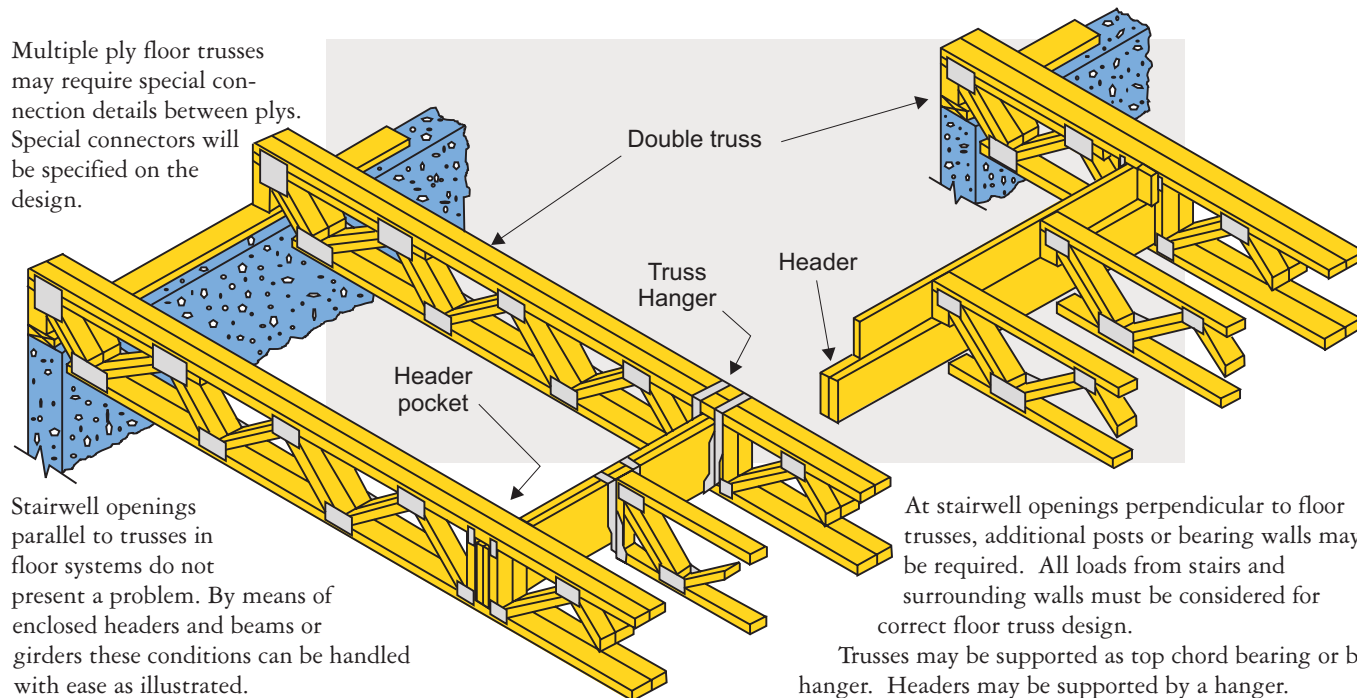

Stairwell openings parallel to trusses in floor systems do not present a problem. By means of enclosed headers and beams or girders these conditions can be handled with ease as illustrated.

At stairwell openings perpendicular to floor trusses, additional posts or bearing walls may be required. All loads from stairs and surrounding walls must be considered for correct floor truss design.

Trusses may be supported as top chord bearing or by hanger. Headers may be supported by a hanger.

Floor Truss Span Tables

These allowable spans are based on NDS 2001. Maximum deflection is limited by L/360 or L/480¹ under live load. Basic Lumber Design Values are $F_{(b)}=2000$ psi $F_{(c)}=1100$ psi $F_{(d)}=2000$ psi $E=1,800,000$ psi Duration Of Load = 1.00. Spacing of trusses are center to center (in inches). Top Chord

Dead Load = 10 psf. Bottom Chord Dead Load = 5 psf. Center Line Chase = 24" max. Trusses must be designed for any special loading, such as concentrated loads. Other floor and roof loading conditions, a variety of species and other lumber grades are available.

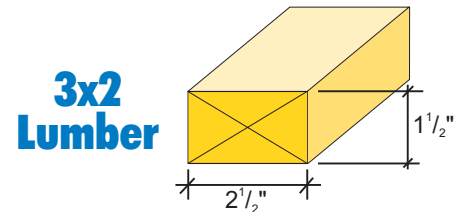
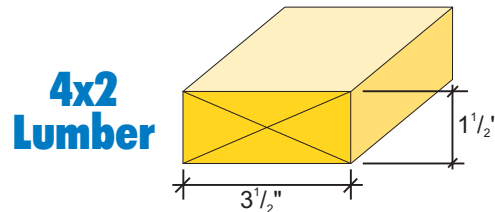

Center Spacing	Deflection Limit	40 PSF Live Load 55 PSF Total Load						40 PSF Live Load 55 PSF Total Load					
		12"	14"	16"	18"	20"	22"	12"	14"	16"	18"	20"	22"
16" o.c.	L/360	22'2"	24'11"	26'10"	28'8"	30'4"	31'11"	19'0"	20'9"	22'4"	23'10"	25'3"	26'7"
	L/480	20'2"	22'7"	24'11"	27'2"	29'4"	31'5"	18'0"	20'2"	22'4"	23'10"	25'3"	26'7"
19.2" o.c.	L/360	20'9"	22'8"	24'4"	26'0"	27'6"	29'0"	17'3"	18'9"	20'3"	21'7"	22'10"	24'1"
	L/480	18'11"	21'3"	23'6"	25'7"	27'6"	29'0"	16'11"	18'9"	20'3"	21'7"	22'10"	24'1"
24" o.c.	L/360	18'5"	20'1"	21'7"	23'1"	24'5"	25'9"	15'2"	16'7"	17'10"	19'1"	20'2"	21'3"
	L/480	17'7"	19'9"	21'7"	23'1"	24'5"	25'9"	15'2"	16'7"	17'10"	19'1"	20'2"	21'3"
16" o.c.	L/360	19'4"	21'4"	23'0"	24'6"	26'0"	27'4"	16'3"	17'9"	19'2"	20'5"	21'8"	22'9"
	L/480	17'7"	19'9"	21'10"	23'9"	25'8"	27'4"	15'9"	17'8"	19'2"	20'5"	21'8"	22'9"
19.2" o.c.	L/360	17'9"	19'4"	20'10"	22'3"	23'7"	24'10"	14'9"	16'1"	17'4"	18'6"	19'7"	20'7"
	L/480	16'7"	18'7"	20'6"	22'3"	23'7"	24'10"	14'9"	16'1"	17'4"	18'6"	19'7"	20'7"
24" o.c.	L/360	15'9"	17'2"	18'6"	19'9"	20'11"	22'0"	13'0"	14'2"	15'3"	16'4"	17'3"	18'2"
	L/480	15'4"	17'2"	18'6"	19'9"	20'11"	22'0"	13'0"	14'2"	15'3"	16'4"	17'3"	18'2"
16" o.c.	L/360	16'11"	18'6"	19'11"	21'3"	22'6"	23'8"	14'1"	15'5"	16'7"	17'8"	18'9"	19'9"
	L/480	15'8"	17'7"	19'5"	21'2"	22'6"	23'8"	14'0"	15'5"	16'7"	17'8"	18'9"	19'9"
19.2" o.c.	L/360	15'4"	16'9"	18'1"	19'3"	20'5"	21'6"	12'9"	13'11"	15'0"	16'0"	16'11"	17'10"
	L/480	14'9"	16'6"	18'1"	19'3"	20'5"	21'6"	12'9"	13'11"	15'0"	16'0"	16'11"	17'10"
24" o.c.	L/360	13'8"	14'10"	16'0"	17'1"	18'1"	19'1"	11'3"	12'3"	13'3"	14'1"	14'11"	15'9"
	L/480	13'8"	14'10"	16'0"	17'1"	18'1"	19'1"	11'3"	12'3"	13'3"	14'1"	14'11"	15'9"

(1) Vibration Control -- Research by Virginia Tech indicates that L/480 live load deflection criteria provides a high degree of resistance to floor vibration (bounce). The building designer

desiring this benefit may choose to specify an L/480 live load deflection criteria to be used for the floor trusses.



Duct Openings For Fan Style Floor Trusses With 4x2 or 3x2 Chords & Webs

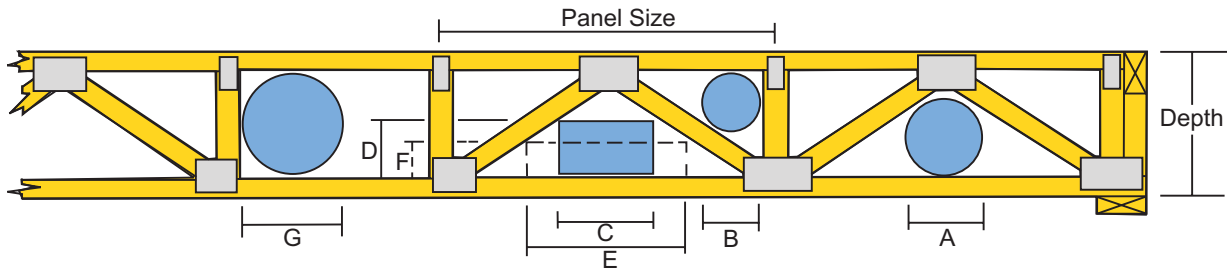

Typical Duct Opening Sizes For 4x2 Fan Style Floor Trusses

Depth	Panel Size	A	B	C	D	E	F	G
10	60	4 ¹ / ₂	4 ¹ / ₄	11	4 ¹ / ₂	16	4	7
11	60	5 ¹ / ₄	5 ¹ / ₄	12	5 ¹ / ₂	15	5	8
11 ⁷ / ₈	60	7 ³ / ₄	6 ³ / ₄	10	6 ¹ / ₄	14	5 ¹ / ₂	8 ³ / ₄
12	60	6 ¹ / ₄	6 ¹ / ₄	14	6	20	5	9
13	60	7 ¹ / ₄	7 ¹ / ₄	12	7	18 ¹ / ₂	6	10
14	60	8 ¹ / ₄	8 ¹ / ₄	17	7	22	6	11
15	60	9 ¹ / ₄	8 ¹ / ₂	15	8	25	6	12
16	60	10 ¹ / ₄	9 ¹ / ₂	14	9	27	6	13
18	60	12 ¹ / ₄	10 ¹ / ₂	14 ¹ / ₂	10 ¹ / ₂	26	7	15
20	60	14	11 ¹ / ₂	14 ¹ / ₂	12	26	8	17
22	60	16	12 ¹ / ₂	15	13	30	8	19
24	60	18	13 ¹ / ₂	16	14	32	8	21
26	60	19	14 ¹ / ₂	18	15	34	8	23
30	60	22	16	20	17	32	10	24
36	60	25	17 ¹ / ₂	22	19 ¹ / ₂	36	10	24

All Dimensions In Inches

Typical Duct Opening Sizes For 3x2 Fan Style Floor Trusses

Depth	Panel Size	A	B	C	D	E	F	G
9 ¹ / ₂	36	5 ¹ / ₂	4 ¹ / ₂	8	3 ¹ / ₂	10	3	6 ¹ / ₂
11 ⁷ / ₈	60	7 ³ / ₄	6 ³ / ₄	10	6 ¹ / ₄	14	5 ¹ / ₂	8 ³ / ₄
11 ⁷ / ₈	54	7 ³ / ₄	6 ¹ / ₂	10	6 ¹ / ₄	14	5 ¹ / ₂	8 ³ / ₄
12	54	7 ³ / ₄	6 ³ / ₄	10	6 ¹ / ₂	14	5 ³ / ₄	9
13	54	8 ³ / ₄	7 ¹ / ₂	12	7	16	6	10
14	54	9 ³ / ₄	8	13	7 ¹ / ₄	16	6 ³ / ₄	11
15	54	10 ¹ / ₂	8 ¹ / ₂	14	7 ³ / ₄	17	7 ¹ / ₄	12
16	54	11 ¹ / ₂	9 ¹ / ₄	15	8 ¹ / ₄	18	7 ³ / ₄	13
18	54	13	10 ¹ / ₄	16	9 ¹ / ₂	20	8 ¹ / ₄	15
20	54	14 ¹ / ₂	11 ¹ / ₄	17	10 ¹ / ₂	22	8 ¹ / ₂	17
22	54	16	12	18	11	24	9	19
24	54	17 ¹ / ₂	13	20	12	26	9 ¹ / ₂	21

All Dimensions In Inches

Maximum duct dimensions are based on a truss plate width of 4 inches. Larger plate widths may cause a reduction in duct sizes. Chase sizes are maximum possible for centered openings.

Trusses are reliable and versatile structural building components when used with certain considerations. Following are some of the more frequently overlooked considerations.

Drainage of Low-Sloping, Flat or Parapet Roofs

Wood trusses, when used as the structural element on flat or relatively flat roofs must have provisions for adequate drainage so as to avoid ponding. Some suggested methods of preventing ponding are illustrated below.

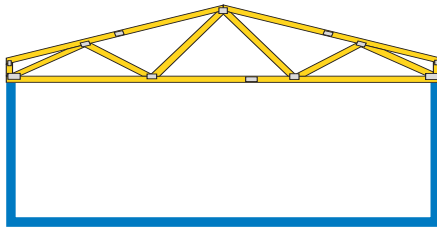

Sloped Top Chord

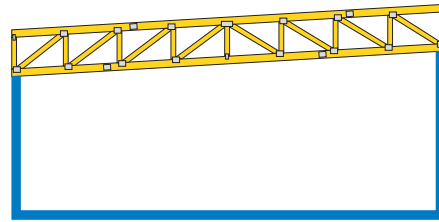

Elevated Bearing

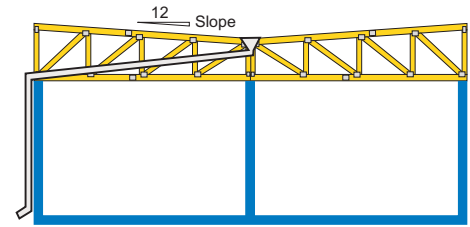

Internal Drain

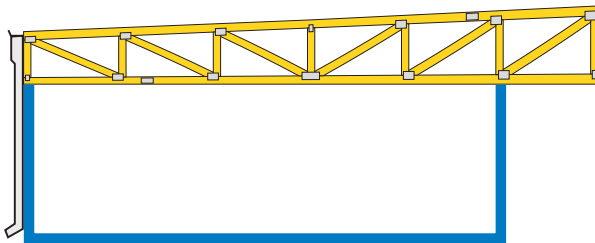

Sloping top chord cantilevered

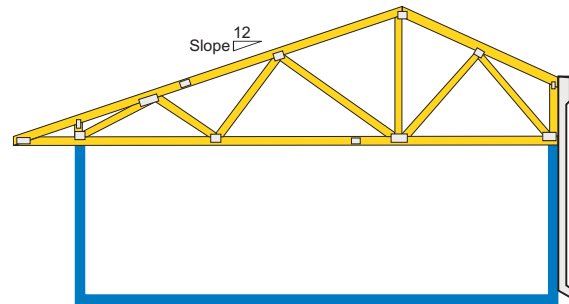

Dual slope top chord cantilevered

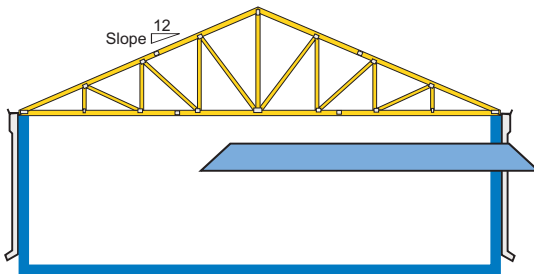

Peaked top chord combined with flat mansard

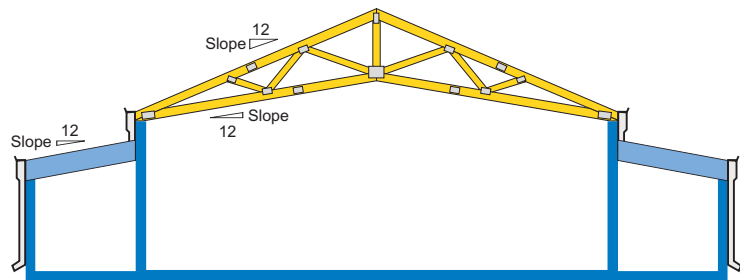

Scissors trusses combined with low slope

Positive Ventilation

When trusses are used in humid or corrosive environments, or when fire resistant wood is required, additional ventilation may be necessary. Any of these conditions may require additional methods to protect the light gauge metal connector plates. Refer to Chapter 6 of ANSI/TPI 2002 for any adjustments to design values and for methods for plate protection.

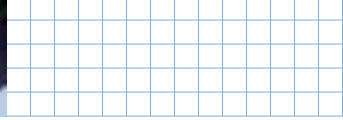

An important consideration in the roof design process is the potential for different snow load conditions. Roofs and buildings that include details or parapets and add-ons such as lean-tos or solar panels need to be designed for possible additional snow accumulation. Roof slope, surface material textures and insulation may also affect snow and ice accumulation.

Annual snowfall also can be affected by regional characteristics such as mountains, flat land, and coastal and inland areas.

The American Society of Civil Engineers (ASCE) publishes *Minimum Design Loads for Buildings and Other Structures (ASCE7)*, which contains a detailed procedure for determining snow drift load.

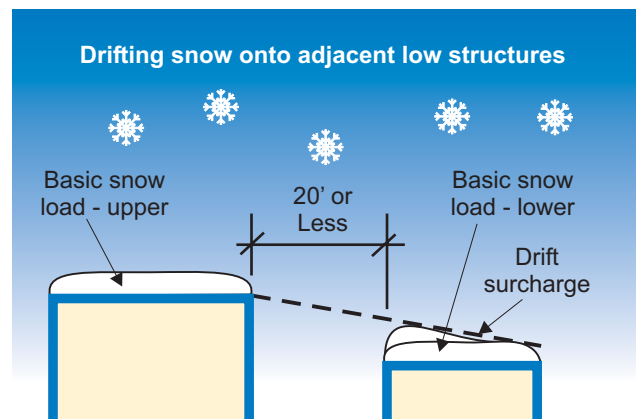
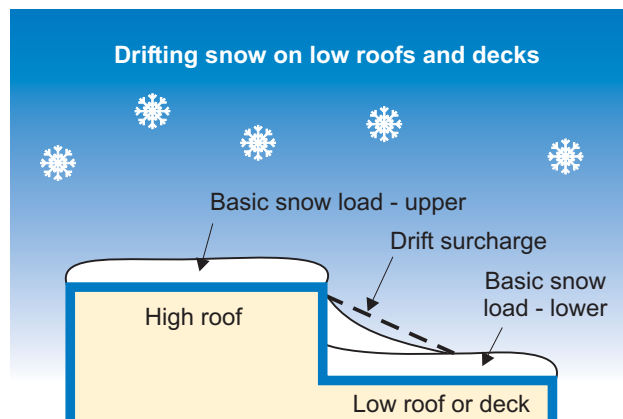
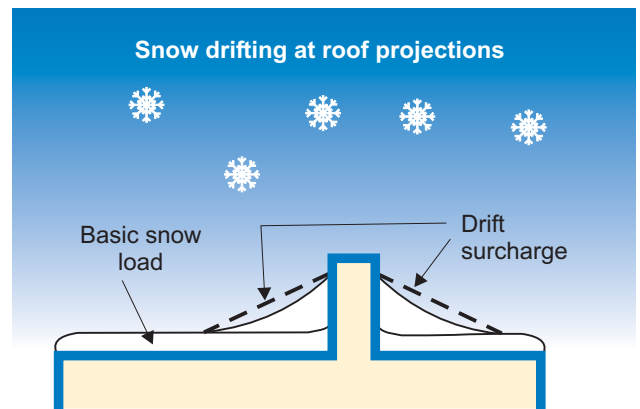
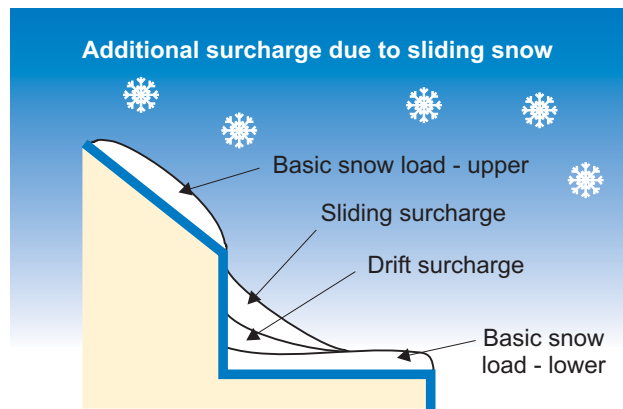
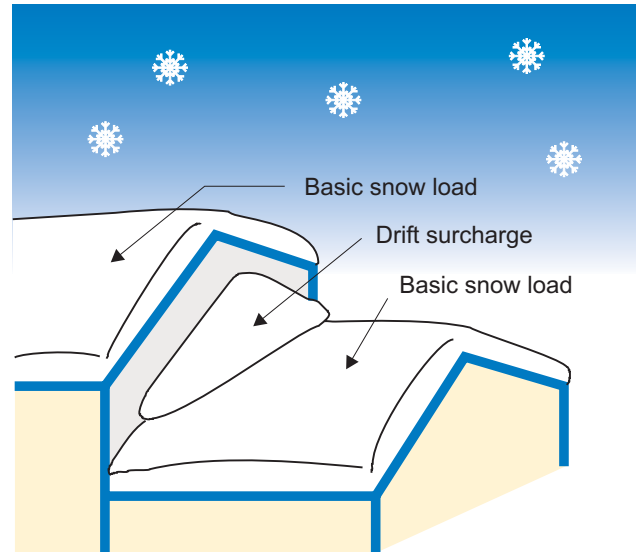

The diagrams above are adopted from the IBC *International Building Code* and IRC *International Residential Code* published by the International Code Council (ICC). They are used here to illustrate some

of the situations that may be encountered when designing a roof system. Actual design procedure as outlined in the applicable code must be consulted when designing for snow.

Metal Plate Connected Wood trusses have performed extremely well when subjected to high wind situations such as hurricanes, down bursts, and tornadoes. Recent extensive investigations of damage to buildings after hurricane Hugo, Andrew, Iniki, and other storms underscore the strong performance of MPCW trusses. The wind load that is used for the design of trusses is dependent upon many factors. The following is a partial listing of factors that may have an influence on the wind loads used for the design of a truss.

- Wind loads are usually required by the local code. This may be one of the major codes, South Florida Code, ASCE 7-98, or other specific local code requirement.
- Location of the building on the “Basic Wind Speed Map”.
- Actual dead load on the trusses to be considered for wind analysis which is usually less than the gravity design dead load.
- Building porosity. Residential buildings are normally assumed to be closed. Agricultural buildings may be closed, partially closed or completely open.
- Exposure category for the building.
- Building application to determine importance factor.
- ASCE 7-98 includes adjustment factors for buildings sited on hills and escarpments. In addition, ASCE wind speeds are based on 3 second gust speed rather than fastest mile speed.
- If the building designer intends a girder truss to be used as a drag strut to transfer lateral loads, it is important that the loads be determined and noted by the building designer.
- It is important that the building designer specify the wind speed, porosity, exposure, and location of the building in addition to other considerations that will influence the design of the truss.
- Special fastening or anchoring devices may be required to attach trusses to the supporting member.

Basic Wind Speed (Miles Per Hour - Fastest Mile)

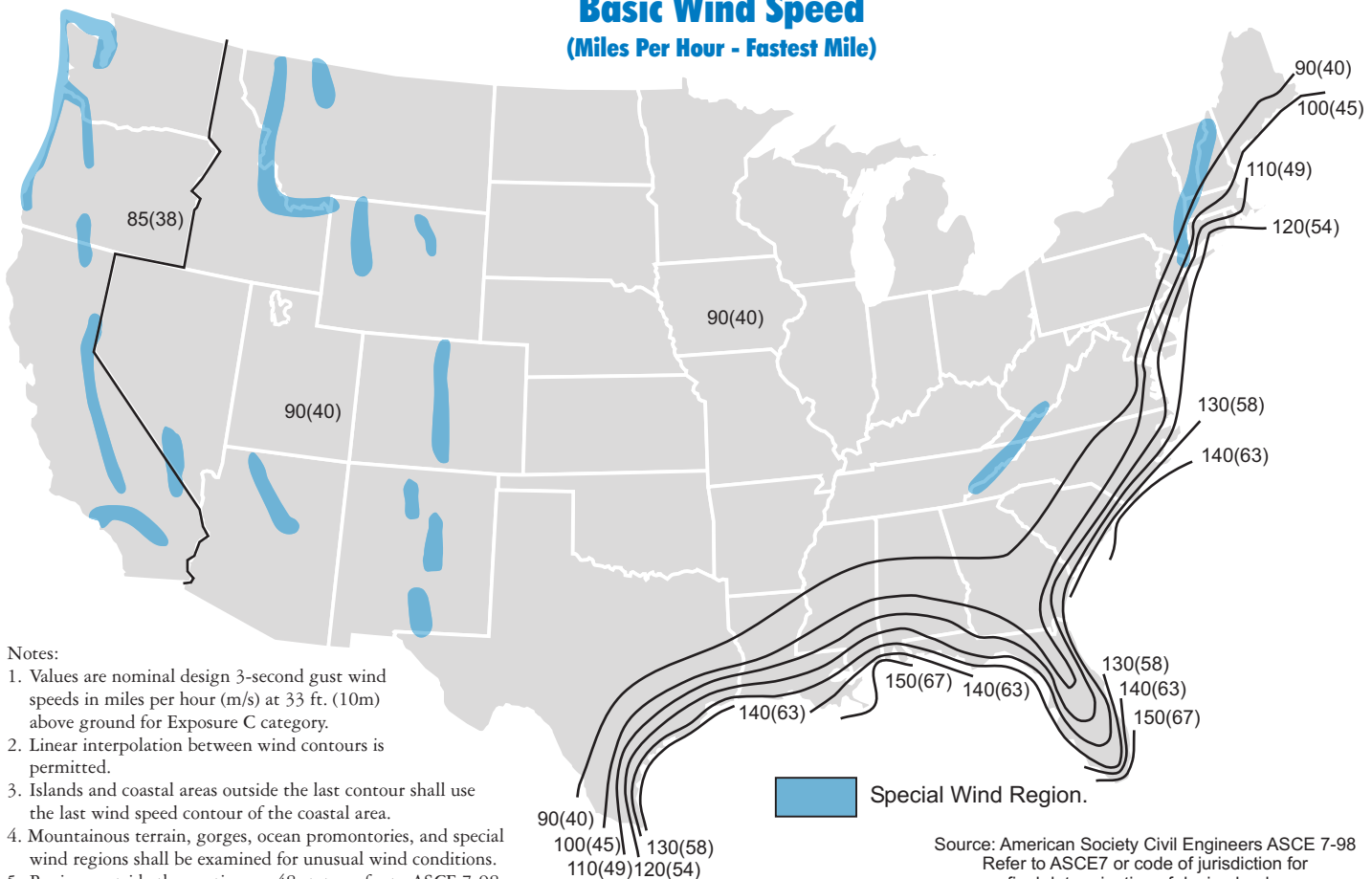

Notes:

1. Values are nominal design 3-second gust wind speeds in miles per hour (m/s) at 33 ft. (10m) above ground for Exposure C category.
2. Linear interpolation between wind contours is permitted.
3. Islands and coastal areas outside the last contour shall use the last wind speed contour of the coastal area.
4. Mountainous terrain, gorges, ocean promontories, and special wind regions shall be examined for unusual wind conditions.
5. Regions outside the contiguous 48 states refer to ASCE 7-98 or your local building official.

Source: American Society Civil Engineers ASCE 7-98
Refer to ASCE7 or code of jurisdiction for final determination of design loads.



1 Hour & 2 Hour Fire Rated Assemblies for Wood Trusses

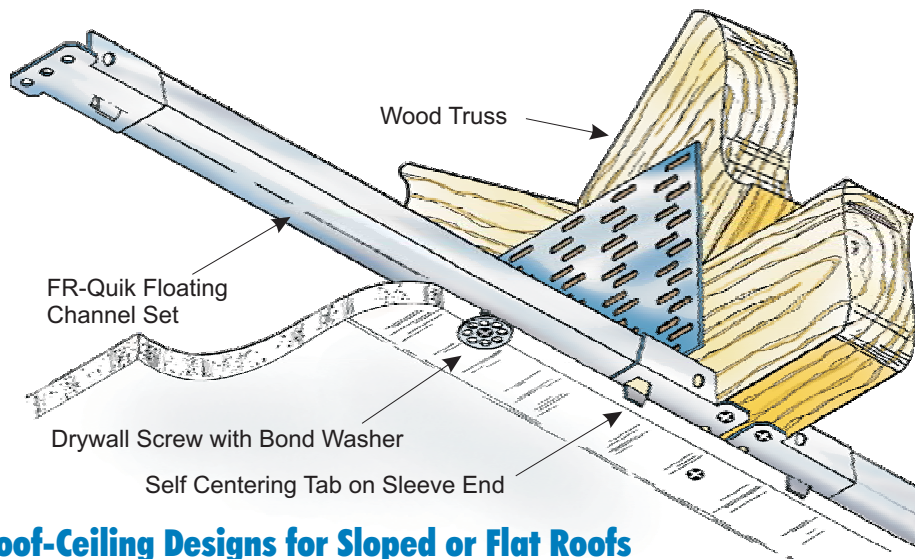

Evaluated by NES - Report NER-392*

*See National Evaluation Report NER-392 for full details on assembly specifications and allowable values and/or conditions of use concerning material presented in this document. All materials shall meet structural requirements of code of jurisdiction. The report is subject to reexamination, revisions and possible closing.

Many multi-family, commercial, industrial, and institutional buildings are required by code to have a fire resistance rating in construction assemblies for floors and roofs. In many cases, assemblies competing with assemblies containing wood trusses have had a lower in-place cost, limiting the use of wood trusses in applications where they would otherwise be more appropriate. Now using FR-Systems with FR-Quik, wood trusses can favorably compete.

FR-Systems Fire Resistance Rated Assemblies consist of gypsum board installed on wood trusses incorporating FR-Quik, an exclusive product by Alpine Engineered Products, Inc. put in place by the drywall contractor as the ceiling board is installed.

Roof-Ceiling Designs for Sloped or Flat Roofs Floor-Ceiling Designs for Parallel Chord Trusses

The fire resistance assemblies described below are based on full-scale tests conducted by recognized independent agencies in accordance with the requirements of ASTM E-119, *Standard Method of Fire Tests of Building Construction and Materials*. When specifying to meet a given fire resistance requirement, the assembly must be constructed within the

limits of the particular test specification referred to by number and source.

For additional information about fire resistant assemblies, request publication *FR-Systems* and/or *Quick Reference* from Alpine's Earth City, Missouri Office - 314-344-9121.

FR-System 1 - One Hour Rated*



- Roof-ceiling or floor ceiling non-insulated plenum or attic.
- Parallel chord 16" min. deep or sloped trusses with 16" heel height.
- Single layer 5/8" Type X gypsum board.

FR-System 2 - Two Hour Rated*



- Roof-ceiling or floor ceiling Insulated or non-insulated plenum or attic.
- Parallel chord 16" min. deep or sloped trusses with 16" heel height.
- Two layers 5/8" Type X improved core gypsum board.

FR-System 3 - One Hour Rated*



- Roof-ceiling or floor ceiling Insulated or non-insulated plenum or attic.
- Parallel chord 15" min. deep or 3/12 (or >) sloped trusses
- Two layers 1/2" Type X gypsum board.

FR-System 5 - One Hour Rated*



- Roof-ceiling or floor ceiling Insulated or non-insulated plenum or attic.
- Parallel chord 9 1/4" min. or wood I-beam
- One layer 5/8" Type X improved core gypsum board.

Sound Control

Ratings of floor-ceiling assemblies are determined by two methods. The Impact Insulation Class (IIC) is measured in accordance with ASTM Standard E-492. Airborne noise

Sound Transmission Class (STC) is measured in accordance with ASTM Standard E-90.

Impact Noise

The IIC listing for floor-ceiling assemblies are generally shown for bare floors and for floors with carpet and pad. Although any carpet, with or without pad, will improve the IIC, a heavy wool carpet over a good quality pad will

make a significant improvement. According to most tests, the addition of a 44 oz. Carpet over a 40 oz hair felt pad increases the IIC from 38 to 63.

Airborne Noise

ASTM Standard E-413 is used to determine the sound transmission class, STC. Some values listed for assemblies tested in 1970 or before were done under a different standard, however, the resulting STC will generally fall in the same range. Airborne sound control is most effective

when air leaks and flanking paths in the assemblies are closed off. Assemblies should be airtight. Recessed fixtures should not be back-to-back in the same cavity. ASTM Recommended Practice E-497 provides good guidance for sound control.

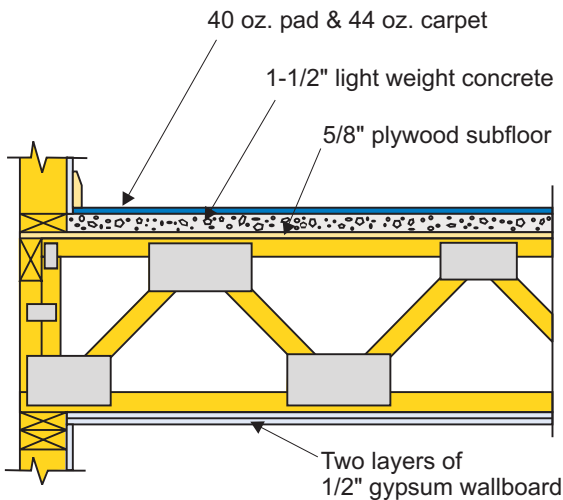

Sound Transmission Class STC=46
Impact Insulation Class IIC=72
 Intest No. 5-425-1

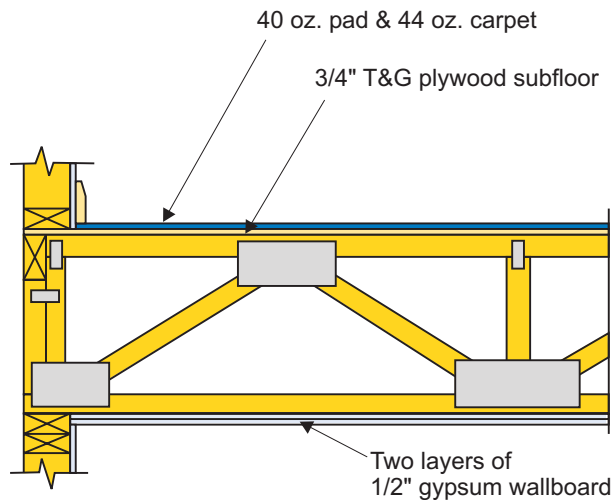

Sound Transmission Class STC=47
Impact Insulation Class IIC=72
 Intest No. 5-425-3

Assembly Test	STC	IIC
Intest		
5-425-1	46	72
5-425-3	47	72
6-442-5	58 FSTC	---
6-442-2	---	53
6-442-3	---	74
87-729-13	59 FSTC	---
87-729-7	---	83 FIIC

Component materials of floor-ceiling assemblies vary greatly causing difficulty in assigning sound ratings. Contributing to the variations are such factors as depth of openings between members, weight of carpet, pads, or other floor coverings thickness of gypsum board etc.





SECTION 06192 FABRICATED WOOD TRUSSES

1.01 Work Included

- A. Fabricate, supply and erect wood trusses as shown on the drawings and as specified. Work to include anchorage, blocking, curbing, miscellaneous framing and bracing.

1.02 Definitions

TRUSS: The term “truss” and “wood truss component” refer to open web load carrying assemblies suitable for support of roof decks or floors in buildings.

FABRICATOR: A manufacturer or fabricator who is regularly engaged in design and fabrication of wood truss components.

TRUSS INSTALLER: Builder, contractor or sub-contractor who is responsible for the field storage, handling and installation of trusses.

1.03 Design

- A. Trusses shall be designed in accordance with these specifications and where any applicable design feature is not specified herein, design shall be in accordance with applicable provisions of latest edition of *National Design Specifications for Wood Construction (NDS)* American Forest and Paper Association (AFPA), and *National Design Standard for Metal Plate Connected Wood Truss Construction (ANSI/TPI 1)*, Truss Plate Institute (TPI), and code of jurisdiction.
- B. Fabricator shall furnish design drawings bearing seal and registration number of a civil or structural engineer licensed in state where trusses are to be installed. Drawings shall be approved by Architect prior to fabrication.
- C. Truss design drawings shall include as minimum information:
 - 1. Span, depth or slope and spacing of trusses;
 - 2. required bearing width;
 - 3. design loads, as applicable:
 - a. top chord live load;
 - b. top chord dead load;
 - c. bottom chord live load;
 - d. bottom chord dead load;
 - e. concentrated loads and their points of application; and
 - f. wind and seismic criteria;
 - 4. adjustment to lumber and plate design values for condition of use;
 - 5. reactive forces, their points of occurrence and direction;
 - 6. ALPINE plate type, gage, size and location of plate at each joint;
 - 7. lumber size, species and grade for each member;
 - 8. location of any required continuous lateral bracing;
 - 9. calculated deflection ratio and/or maximum deflection for live a
 - 10. maximum axial forces in truss members;
 - 11. location of joints;
 - 12. connection requirements for:
 - a. truss to truss girders;
 - b. truss ply to ply; and
 - c. field splices.



2.01 Materials

A. Lumber:

1. Lumber used for truss members shall be in accordance with published values of lumber rules writing agencies approved by board of review of American Lumber Standards Committee. Lumber shall be identified by grade mark of a lumber inspection bureau or agency approved by that board, and shall be as shown on design drawings.
2. Moisture content of lumber shall be no less than 7 percent nor greater than 19 percent at time of fabrication.
3. Adjustment of values for duration of load or conditions of use shall be in accordance with *National Design Specification for Wood Construction (NDS)*.
4. Fire retardant treated lumber, if applicable, shall meet specifications of truss design and ANSI/TPI 1-2002, par 6.4.9.1 and shall be redried after treatment in accordance with AWPA Standard C20. Allowable values must be adjusted in accordance with NDS par 2.3.4. Lumber treater shall supply certificate of compliance.

B. Metal connector plates:

1. Metal connector plates shall be manufactured by ALPINE and shall be not less than .036 inches in thickness (20 gage) and shall meet or exceed ASTM A653 grade 40, and shall be hot dipped galvanized according to ASTM A653, coating designation G60. Working stresses in steel are to be applied to effective ratios for plates as determined by test in accordance with Chapter 5 of ANSI/TPI 1-2002.
2. In highly corrosive environments, special applied coatings or stainless steel may be required.
3. At the request of Architect, ALPINE shall furnish a certified record that materials comply with steel specifications.

2.02 Fabrication

- A. Trusses shall be fabricated in a properly equipped facility of a permanent nature. Trusses shall be fabricated by experienced workmen, using precision cutting, jiggling and pressing equipment meeting requirements of ANSI/TPI 1-2002, Chapter 3. Truss members shall be accurately cut to length, angle and true to line to assure proper fitting joints within tolerances set forth in ANSI/TPI 1-2002, Chapter 3 and proper fit with other work.

3.01 Handling, Installation and Bracing

- A. Trusses shall be handled during fabrication, delivery and at job site so as not to be subjected to excessive bending.
- B. Trusses shall be unloaded on smooth ground to avoid lateral strain. Trusses shall be protected from damage that might result from on-site activities and environmental conditions. Prevent toppling when banding is removed.
- C. Handle during installation in accordance with *Handling, Installing and Bracing Wood Trusses (HIB-91)*, TPI, and ANSI/TPI 1-2002. Installation shall be consistent with good workmanship and good building practices and shall be responsibility of Truss Installer.
- D. Apparent damage to trusses, if any, shall be reported to Fabricator prior to installation.
- E. Trusses shall be set and secured level and plumb, and in correct location. Trusses shall be held in correct alignment until specified permanent bracing is installed.
- F. Cutting and altering of trusses is not permitted.
- G. Concentrated loads shall not be placed atop trusses until all specified bracing has been installed and decking is permanently nailed in place. Specifically avoid stacking full bundles of decking or other heavy materials onto unsheathed trusses.
- H. Erection bracing is always required. Professional advice should always be sought to prevent toppling or dominoing of trusses during installation.
- I. The Contractor is responsible for obtaining and furnishing the materials used for installation and permanent bracing.

END SECTION



(Short Form)

SECTION 06192 FABRICATED WOOD TRUSSES

1.01 Work Included:

- A. Fabricate, supply and erect wood trusses as shown on the drawings and as specified. Work to include anchorage, blocking, curbing, miscellaneous incidental framing and bracing.

1.02 Design:

- A. Trusses shall be designed in accordance with *National Design Specification for Wood Construction, AFPA*, and *National Design Standard For Metal Plate Connected Wood Truss Construction, ANSI/TPI 1-2002*, and the Code of jurisdiction.
- B. Fabricator shall furnish design drawings bearing the seal and registration number of design professional licensed in the state where trusses are to be installed.
- C. Drawings shall be approved by Architect prior to fabrication.

2.01 Materials:

- A. Lumber used shall be identified by grade mark of a lumber inspection bureau or agency approved by Board of Review of American Lumber Standards Committee, and shall be size, species and grade in accordance with design drawings.
- B. Connector plates shall be by ALPINE and shall meet or exceed ASTM A653 requirements for structural steel.

2.02 Fabrication:

- A. Trusses shall be fabricated as set forth in ANSI/TPI 1-2002 in accordance with the design drawings by an established fabricator.

3.01 Handling and Installation:

- A. Trusses shall be handled during fabrication, delivery and at job site so as not to be subjected to excessive lateral bending.
- B. Installation shall be in accordance with *Handling, Installing and Bracing Wood Trusses, HIB-91, TPI*. Trusses shall be set and secured level and plumb, and in correct location.
- C. Trusses shall be sufficiently braced during installation to prevent toppling or dominoing. Install all bracing before placing concentrated loads atop trusses.
- D. Cutting and altering of trusses is not permitted.

END SECTION

Typical Roof Truss Design

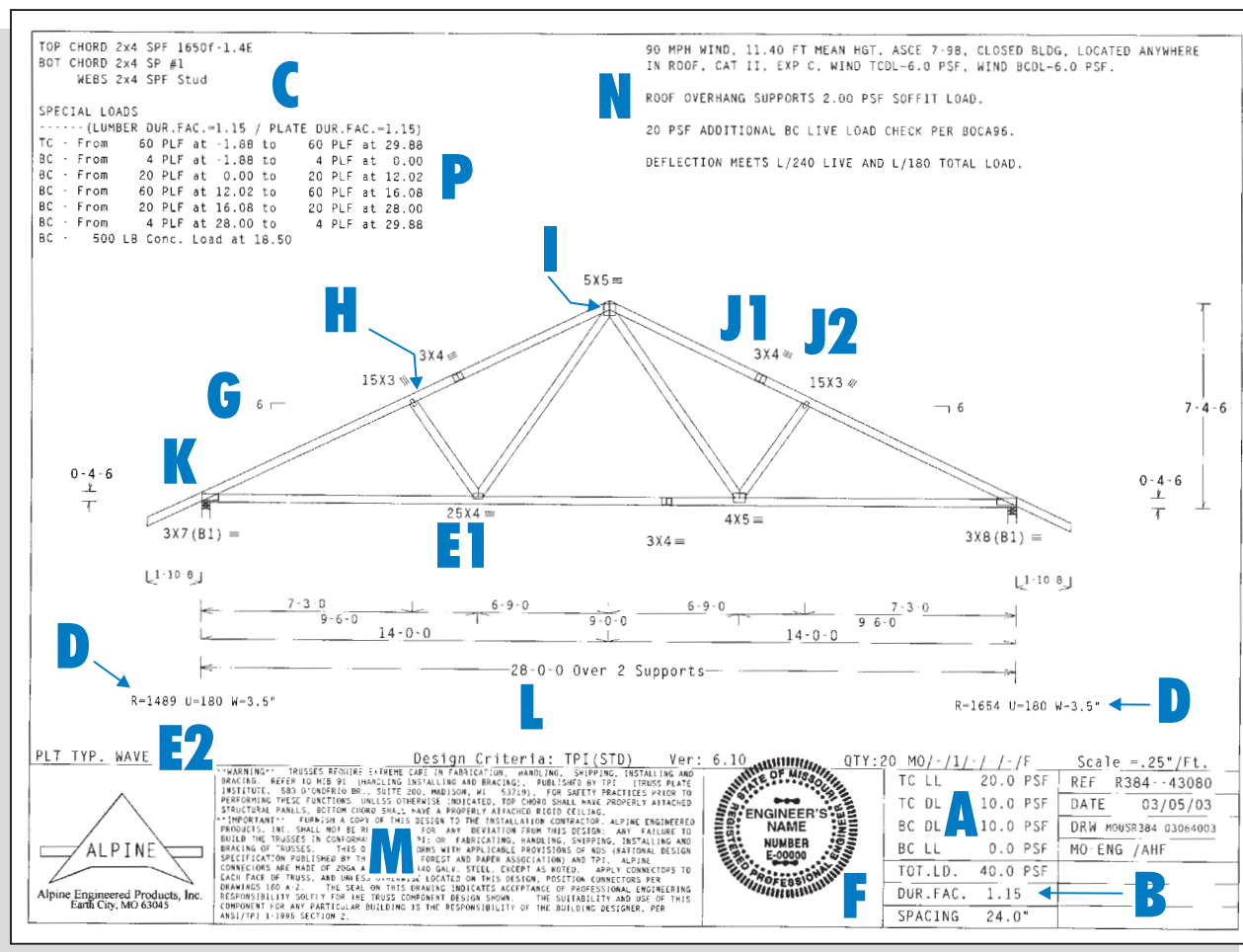

A Design Loading

Top and bottom chord dead and live loads (including snow load) in pounds per square foot as used in the analysis.

B Load Duration Factor

An adjustment of allowable design values of lumber and fasteners.

C Lumber Specifications

Lumber size, species and grade for each member as used in the analysis.

D Reaction

The force in pounds on the bearings produced by the truss at design load, the uplift due to the wind load, and the bearing width.

E1 & E2 Connector Plates

The series, size and orientation.

F Engineers Seal

Seal of the registered professional responsible for the design.

G Slope

The vertical rise in inches for every 12 inches of horizontal run.

H Panel Points

The joints of the truss where the webs intersect the chords.

I Peak

The intersection of two chords where the slope changes from positive to negative. Generally at the centerline of the truss.

J1 & J2 Splices

Where two chord pieces join together to form a single member. J1 shows the location, J2 the corresponding connector plate.

K Heel

The point of the truss where the top and bottom chord intersect, generally at a bearing point.

L Span

The nominal span based on out-to-out dimensions of the supports or the bottom chord length, whichever is greater.

M General Notes

Notes that apply to all Alpine design drawings.

N Special Notes

Notes that apply only to this specific design drawing.

P Load Note

Notes that show the magnitude and location of all loads on the truss.

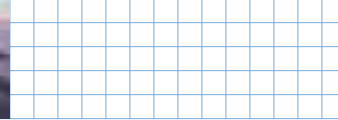

Builder's And Contractor's Reference Section

Responsibility

According to the publication *National Standard and Recommended Guidelines on Responsibilities for Construction Using Metal Plate Connected Wood Trusses - ANSI/TPI/WTCA 4-2002*, published jointly by the Wood Truss Council of America (WTCA) and the Truss Plate Institute (TPI), responsibility for wood trusses is divided among the owner, building designer, the truss designer, contractor or builder (installer) and the truss manufacturer.

- The building designer is responsible for design of the building's structural system. This includes specifying truss profiles and all truss loading requirements, permanent bracing design and design of the structure supporting the trusses.
- The truss designer is responsible for the design of the individual truss components in accordance with the owner's or building designer's written specifications.
- The truss manufacturer is responsible for manufacturing the trusses in accordance with the approved design drawings and the quality criteria in TPI 1.

- The builder and truss installer are responsible for the safe handling and installation of trusses after they reach the jobsite. They are also responsible for installing both the temporary and permanent bracing per the building designer's bracing design or the prescriptive requirements of HIB-91.

A good guide for these areas of responsibility is *Handling, Installing and Bracing Metal Plate Connected Wood Trusses - HIB-91* published by the Truss Plate Institute (TPI). The publication is also available in a six page fold-out summary form for use as a jobsite reference. It is recommended that all persons associated with the installation process read and adhere to the recommendations of this publication to help prevent injury to themselves, other workers and property.

A good publication for guidance in the design of a temporary bracing system is the publication *Recommended Design Specifications for Temporary Bracing of Metal Plate Connected Wood Trusses, DSB-89*, published by the Truss Plate Institute (TPI).

WARNING:

Do not cut or notch any truss member without permission of the truss designer.
Do not use or repair damaged trusses without professional consultation with the Architect, Engineer or Truss Designer.



Your truss manufacturer produces quality trusses using standards recommended by Alpine and the Truss Plate Institute (TPI). These standards include provisions for tight joints, accurate dimensions, proper plate placement and material storage. Similar provisions to protect the quality should be continued through delivery, storage, handling, erection and bracing in order to maintain the structural reliability and strength of the trusses. Finished trusses are usually banded with steel strapping in convenient size bundles. The strapping helps maintain truss

alignment and the bundle strength minimizes damage during storage and delivery.

Your manufacturer will normally store trusses vertically in racks or horizontally with blocking to prevent lateral bending. Throughout all phases of construction, care must be taken to avoid excessive lateral bending of the trusses which can cause joint and lumber damage.

WARNING: Exercise care in removing steel strapping to prevent injury.

Banded trusses for delivery are transported to the jobsite on flatbed trailers with a roller deck or on special “pole-type” trailers.

If possible, trusses should be unloaded on relatively smooth ground. They should not be unloaded on rough terrain that would cause undue lateral strain resulting in distortion of the truss joints.

Rough terrain can also cause damage or breaking of overhangs, soffit returns, and other parts of the truss.

Proper banding and smooth ground allows for dumping of trusses without damage. This should be done as close to the building site as possible to minimize handling.

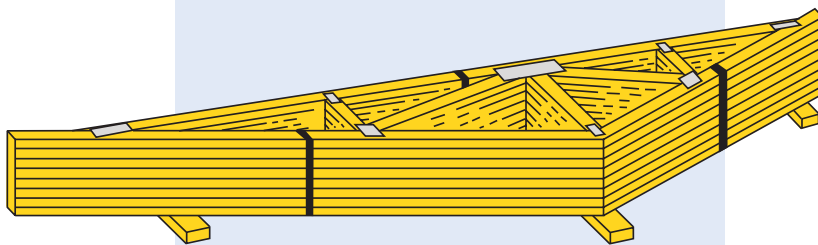
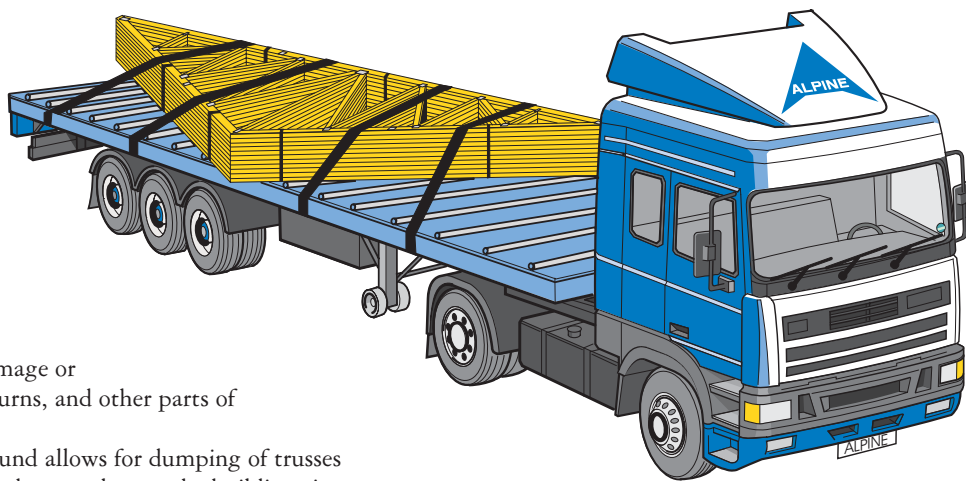

If trusses are not to be immediately installed, several provisions should be made.

Truss bundles may be unloaded and stored in the horizontal or vertical position. If the trusses are horizontal, they should be blocked above ground to protect them from ground water and termites.

Blocking should be on eight to ten foot centers to prevent lateral bending. Be sure the blocking is solid in order to prevent toppling or sliding.

If trusses are in the vertical position they should be staked on both sides of the bundle to prevent toppling and personal injury.

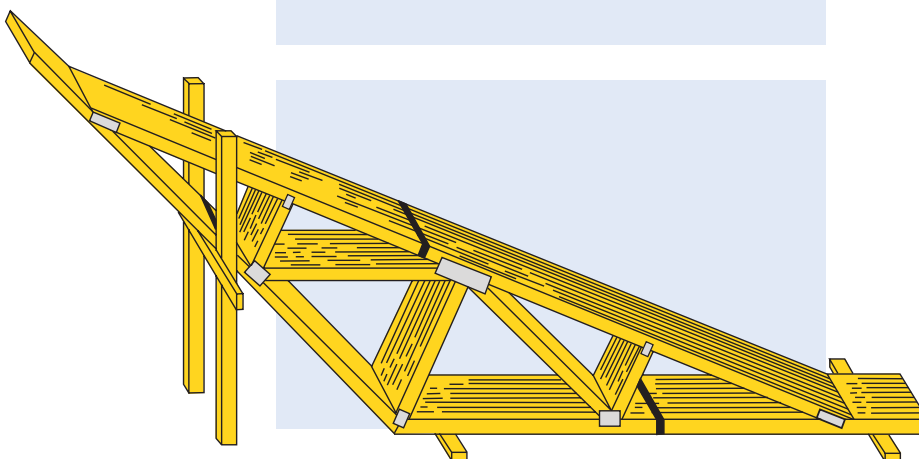

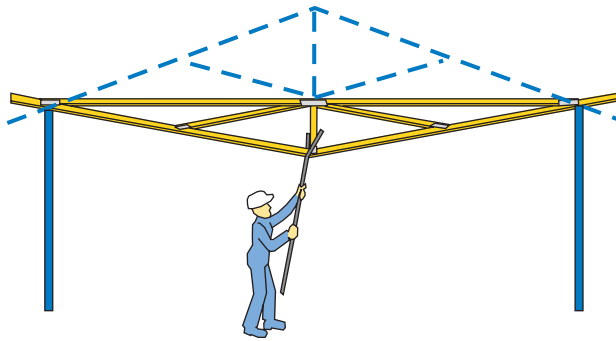
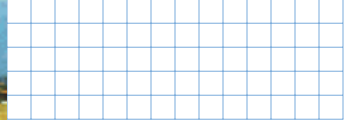

Manual Installation

Trusses may be installed manually, by crane, or by forklift, depending on truss size, wall height and job conditions. Individual trusses should always be carried vertically to avoid lateral strain and damage to joints and members.

Trusses installed manually are slid into position over the sidewall and rotated into place using poles. The longer the span, the more workers are needed to avoid excessive lateral strain on the trusses. Trusses should be supported at joints and the peak while being raised.

Large trusses should be installed by a crane or forklift employing chokers, slings, spreader bars and strongbacks to prevent lateral bending. Trusses may be lifted singly, in banded groups, or preassembled in groups.

Tag lines should always be used to control movement of trusses during lifting and placement.

Refer to *Handling, Installing and Bracing Metal Plate Connected Wood Trusses (HIB-91)* by the Truss Plate Institute, or *Wood Truss Erection* poster by the Wood Truss Council of America for proper methods of installation.

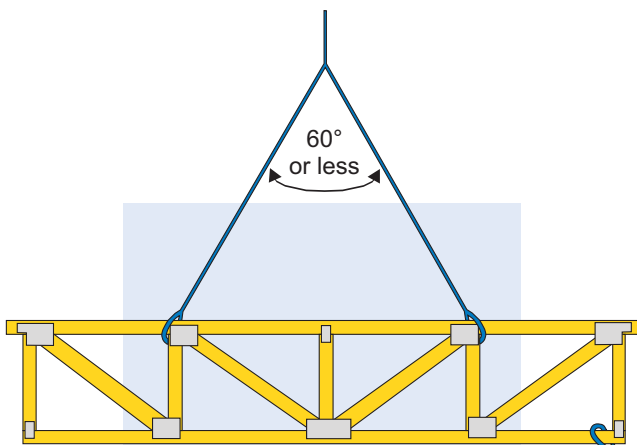

Using A Sling

Typical Tag Line

Installation procedures are the responsibility of the installer. Job conditions and procedures vary considerably. These are only guidelines and may not be proper under all conditions.

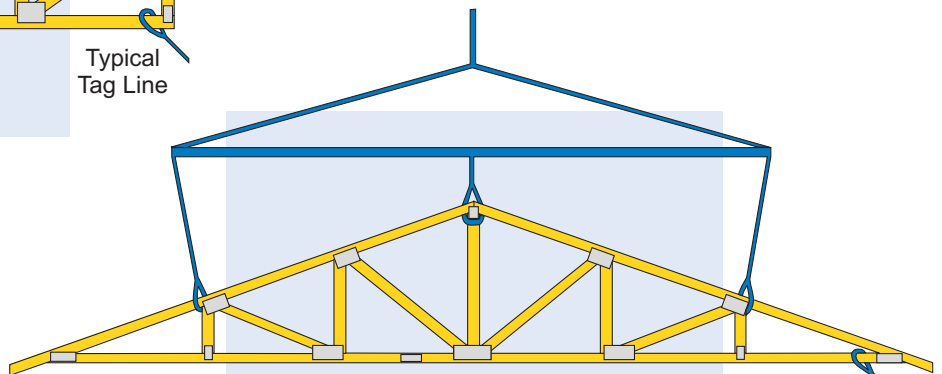

Using A Spreader Bar

Typical Tag Line

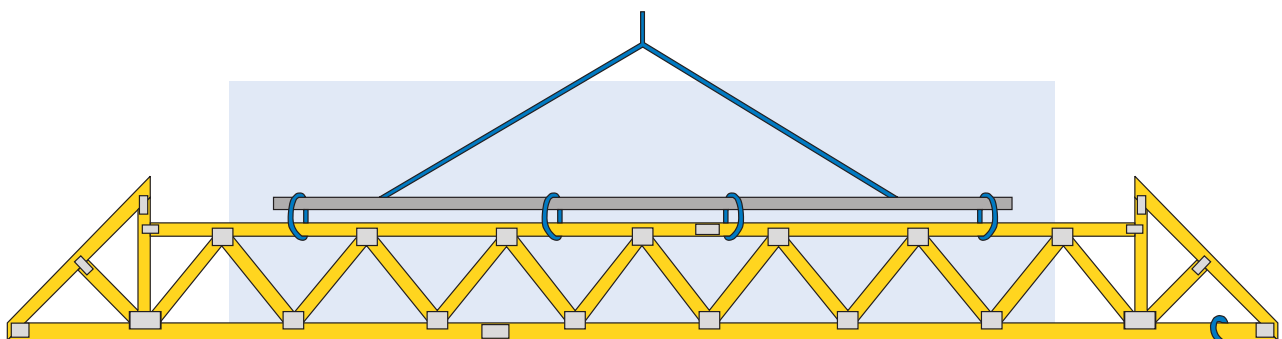

Using A Strongback

Typical Tag Line

Guidelines For Installation Of Bracing From HIB-91

All trusses must be securely braced, both during erection and after permanent installation. Individual wood trusses are designed only as structural components. Responsibility for proper bracing always lies with the building designer and contractor for they are familiar with local and job-site conditions and overall building design.

All trusses should be installed straight, plumb and aligned at the specified spacing. Trusses should also be inspected for structural damage.

There are two types of bracing. Temporary bracing is used during erection to hold the trusses until permanent bracing, sheathing and ceilings are in place. Permanent bracing makes the truss component an integral part of the roof and building structure. Temporary and permanent bracing includes diagonal bracing, cross bracing and lateral bracing.

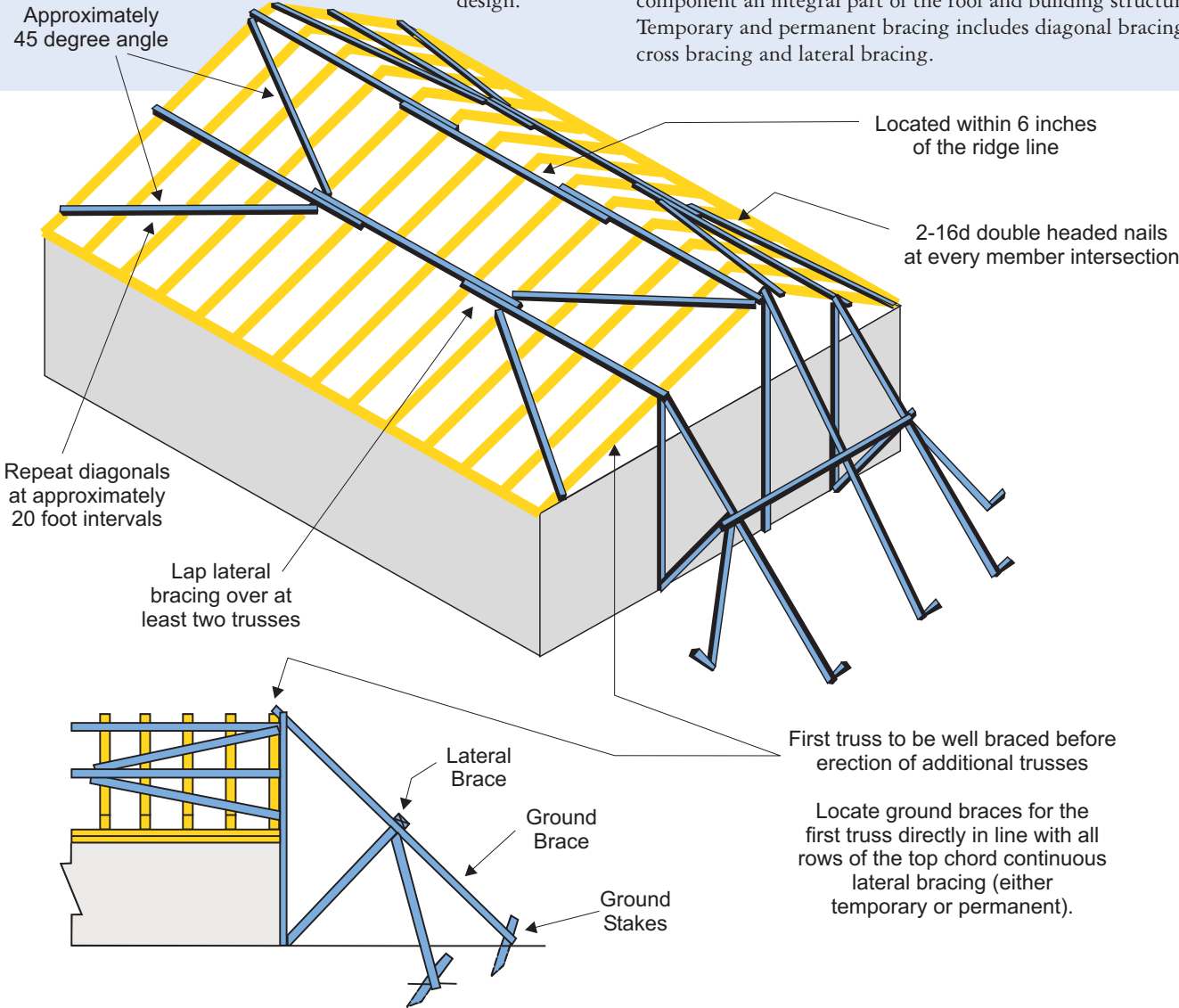

Permanent lateral bracing, as may be required by truss design to reduce the buckling length of individual truss members, is part of the wood truss design and is the only bracing specified on the design drawing. This bracing must be sufficiently anchored or restrained by diagonal bracing to prevent its movement. Most truss designs assume continuous top and bottom chord lateral support from sheathing and ceilings. Extra lateral and diagonal bracing is required if this is not the case.

Bracing members should be 2x4 nailed with two 16d nails at each cross member unless specified otherwise on the design drawing. Lateral braces should be at least 10 feet long. Cross and diagonal braces should run on an approximate 45 degree angle.

It is important to temporarily brace the first truss at the end of the building. One method calls for the top chord to be braced by ground braces that are secured by stakes driven in the ground, preferably outside and inside. The bottom chord is to be securely anchored to the end wall.

Adjacent trusses are now set connecting each to continuous lateral bracing on the top chord. These are typically spaced at 6', 8' or 10 feet on centers along the length of the truss. Refer to HIB-91 for diagonal spacing.

This top chord bracing will be removed as the sheathing is applied after the other bracing is completed.

Temporary Bracing



Temporary bracing should be 2x4 dimension lumber or larger and should be 8 feet minimum in length. Continuous lateral bracing maintains spacing, but without cross bracing, permits trusses to move laterally. See HIB-91.

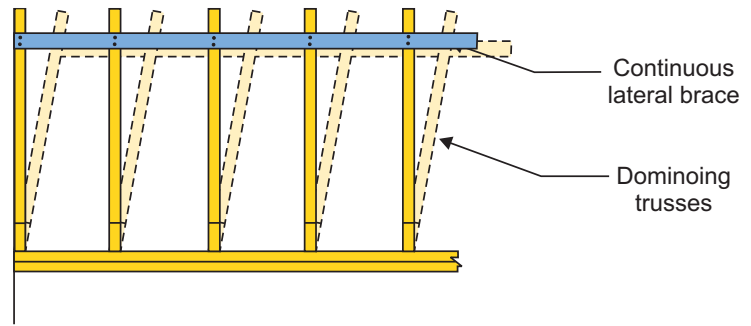

To prevent dominoing, cross bracing should be installed in the plane of the webs as the trusses are installed. See HIB-91.

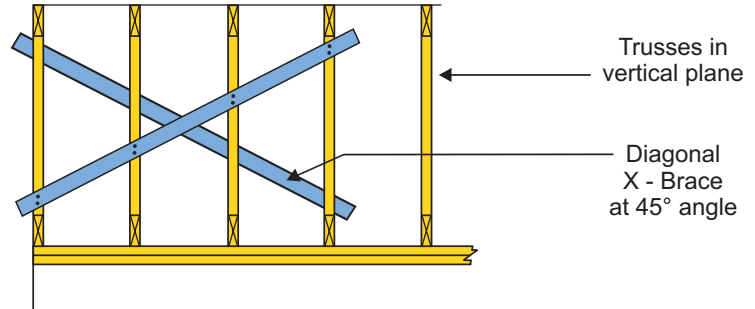

Top View

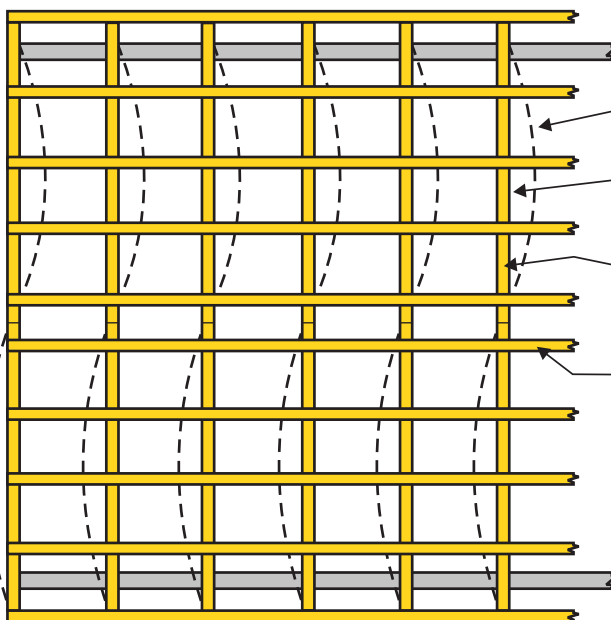

All top chords can buckle together if there is no diagonal bracing

Top chords can buckle despite frequent purlins

Top Chord (typical)

Continuous purlins (typical)

Diagonals form braced bay. Repeat at both ends and at approximately 20 foot intervals.

Diagonal bracing nailed to the under side of the top chord prevents lateral movement of the top chord.

Top View

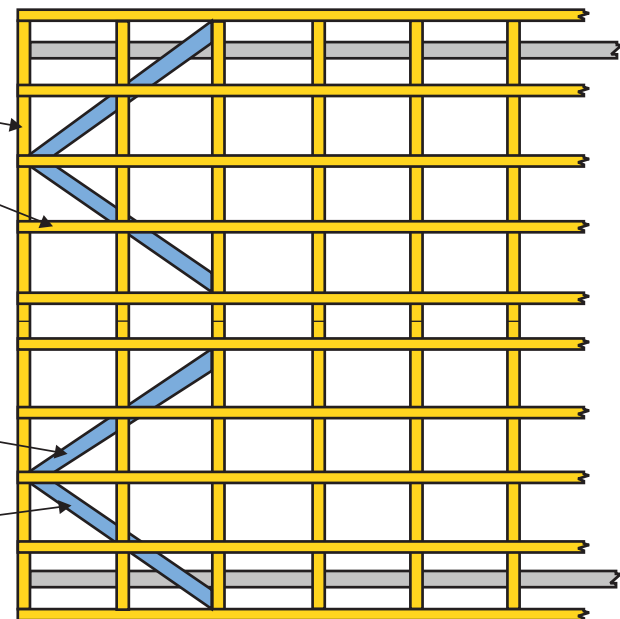

Full bundles of sheathing should not be placed on the trusses. They should be limited to 8 sheets to a pair of trusses. Likewise, other heavy concentrated loads should be evenly distributed. Inadequate bracing is the reason for most wood truss installation failures. Proper installation is a vital step for a safe and quality roof structure.

These recommendations are offered only as a guide. Refer to *Recommended Design Specifications for Temporary Bracing of Metal Plate Connected Wood Trusses (DSB-89)* by the Truss Plate Institute (TPI), or *Handling, Installing and Bracing (HIB-91)* by TPI.

Web Bracing Installation

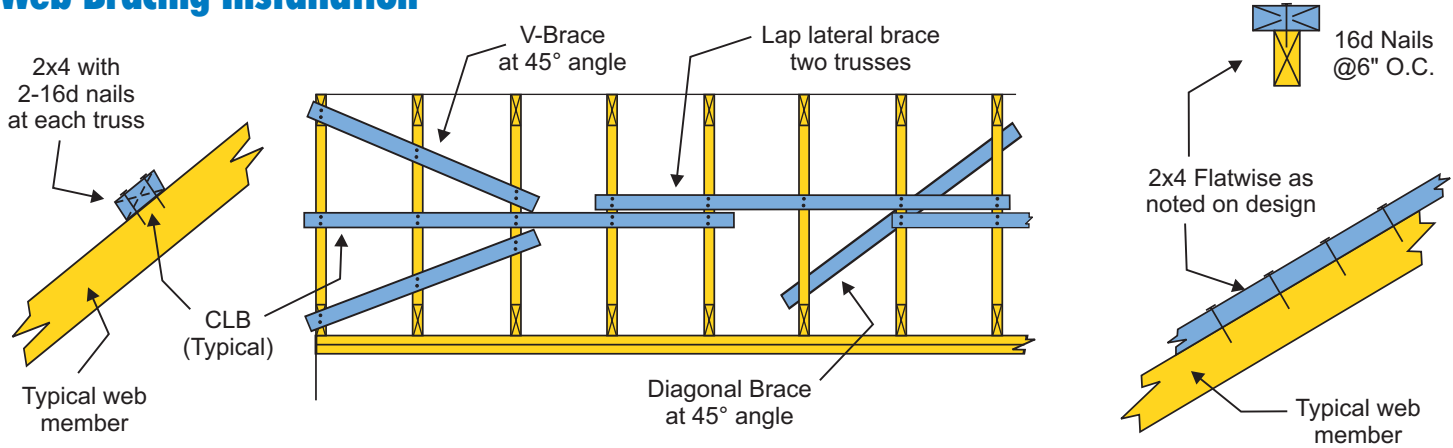

Continuous Lateral Bracing

When continuous lateral bracing (CLB) is specified on the design drawing, the CLB shall be installed and connected to each end of the building and cross-braced at intervals determined by the building designer.

T-Brace

The T-Brace is typically used with hip trusses.

Typical Bottom Chord Bracing (CLB)

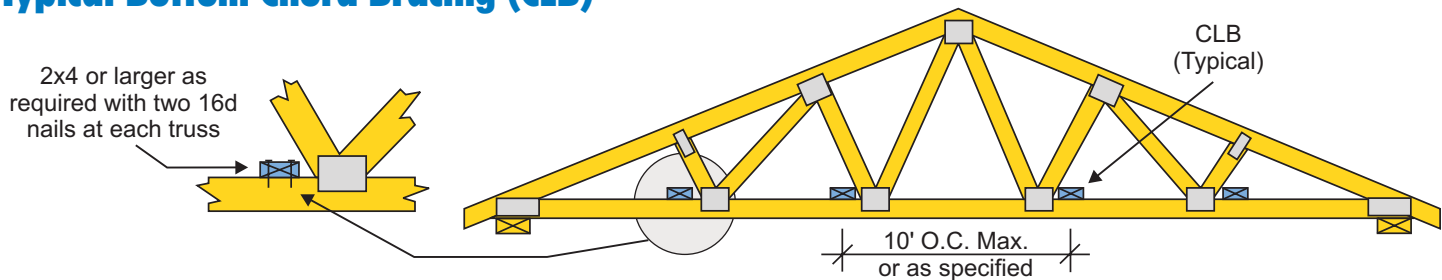

Where the building design does not provide for a ceiling diaphragm or other means of continuous lateral bracing of the bottom chord of the truss, the truss design will specify the

spacing of the continuous lateral bracing of the bottom chord. NOTE: The building designer is responsible for the design of the roof, floor and building bracing.

Strongbacks

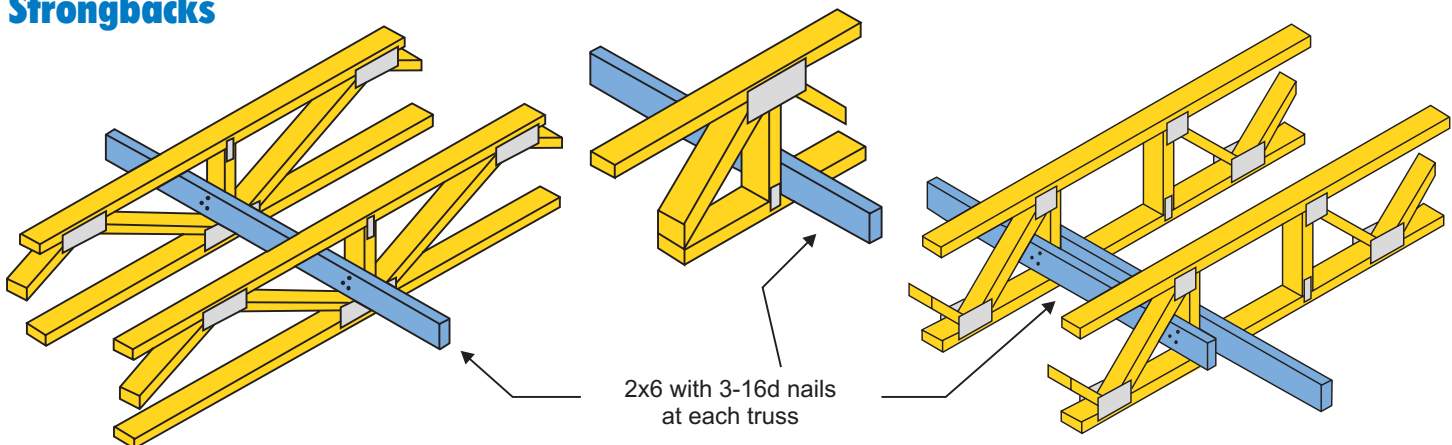

Strongbacks, 2x6 minimum, should be secured to a vertical member with 3-16d nails on floor trusses. For spans less than 20 feet, one row of strongbacking at the centerline is sufficient. For spans greater than 20 feet and less than 30 feet, use two rows of strongbacking equally spaced. In general, use one strongback

row for each 10 feet of truss span. Blocking behind the vertical is recommended while nailing the strongback in place. Strongback lumber should be at least 14 feet in length and lapped two feet at their ends over two adjacent trusses.



Typical Bracing for Piggyback Trusses

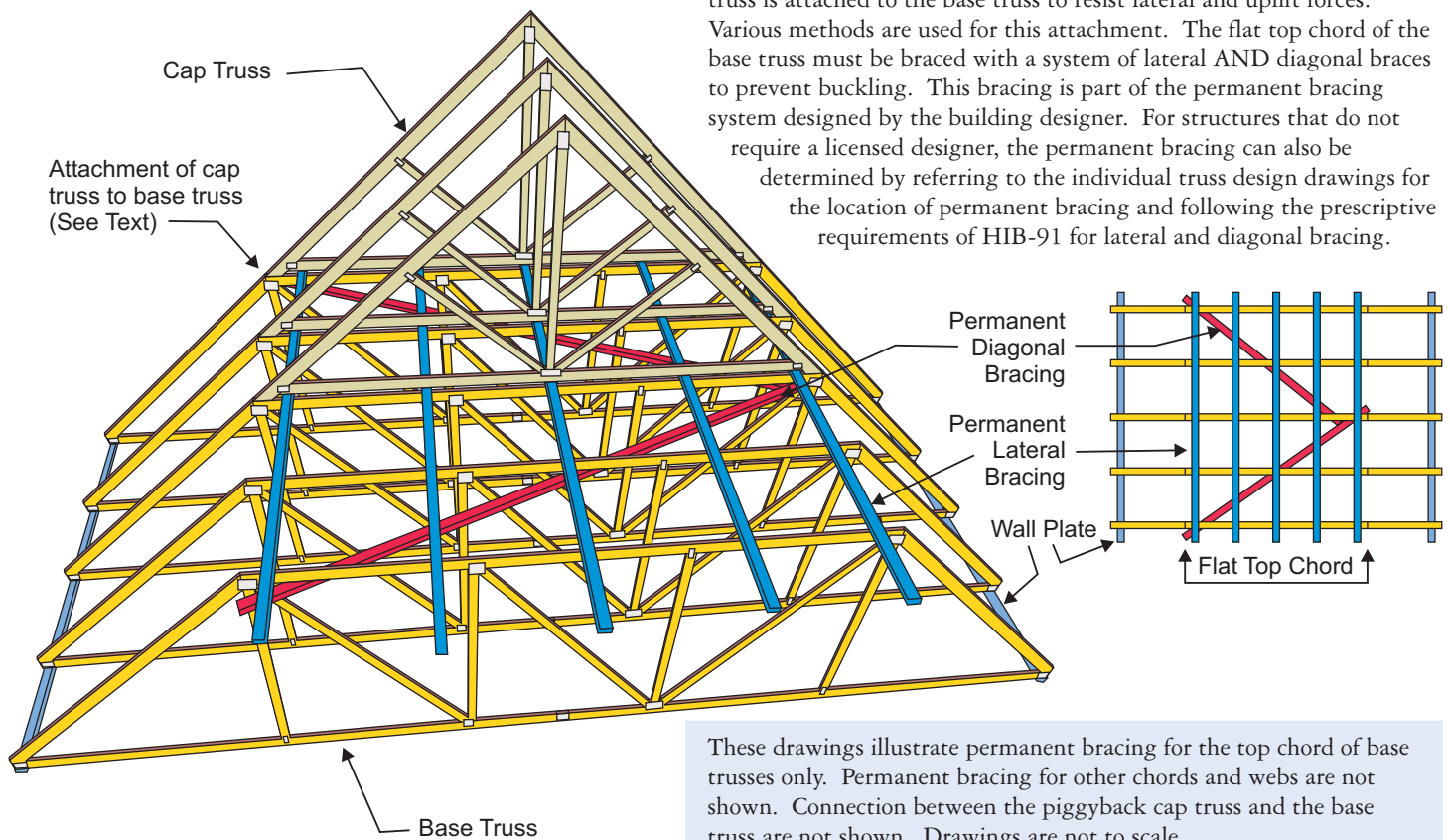

If a truss is too tall to build and/or haul in one piece, a cap truss can be used on top of a base truss to form the overall height required. The cap truss is attached to the base truss to resist lateral and uplift forces. Various methods are used for this attachment. The flat top chord of the base truss must be braced with a system of lateral AND diagonal braces to prevent buckling. This bracing is part of the permanent bracing system designed by the building designer. For structures that do not require a licensed designer, the permanent bracing can also be determined by referring to the individual truss design drawings for the location of permanent bracing and following the prescriptive requirements of HIB-91 for lateral and diagonal bracing.

These drawings illustrate permanent bracing for the top chord of base trusses only. Permanent bracing for other chords and webs are not shown. Connection between the piggyback cap truss and the base truss are not shown. Drawings are not to scale.

Web-Block Engineered Bracing Solution

The Alpine Web-Block is a reinforcement method for strengthening the buckling capacity of wood webs and minimizing the use of field-applied braces such as T-braces, L-braces or continuous lateral braces. The Alpine Web-Block consists of an additional 2x4 web member plated to the side of the existing web member, narrow-face to narrow-face. This results in increased bending strength of the web, which results in increased strength for webs that are susceptible to buckling.

Advantages of Alpine Web-Block:

- Exists entirely within the plane of the truss and does not affect truss stacking, so it can be applied at the truss plant.
- Saves truss installation contractors time and trouble by not having to install bracing after erection or source bracing materials and fasteners.
- Increases job site safety by reducing the need for installers to climb through trusses to install bracing members.
- Consists of standard plates and web material, so no new supplies or equipment are required.
- Permits truss fabricators to increase sales by selling additional web material while minimizing problems due to call-backs and contractor complaints from missing bracing.
- Is lower cost than the competing cold-formed-steel reinforcing members on the market.

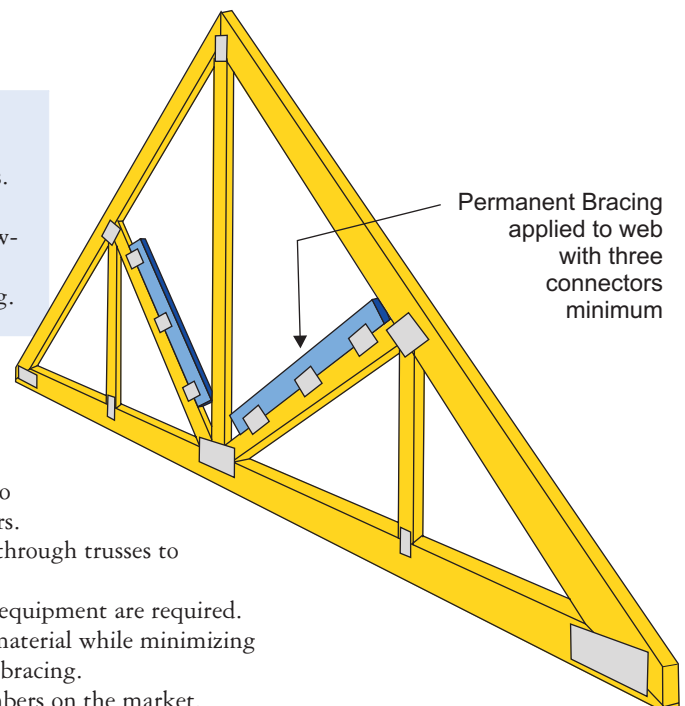

The Importance of Proper Bracing in Structural Performance



The structural performance of a frame building depends on continuous paths for all loads to eventually be transferred to the ground. In the specific instance of pre-engineered trusses, there are several types of bracing, which are sometimes confused. Each of these types of bracing is important to the construction process and ultimately to the structural integrity of the building.

There are two distinct types of bracing. Temporary or construction bracing is the first type, and permanent bracing is the second type.

Temporary or Construction Bracing:

This is the proper bracing of the trusses during the erection phase of the structure. Much like walls are braced until the completion of the framing process, when trusses are placed on the plate line, they must be braced to hold them safely and securely in place and to resist environmental influences such as wind gusts during the framing process. Temporary bracing guidelines are available through truss industry documents for truss spans up to 60 ft. For spans over 60 ft. a professional engineer should be consulted for the temporary bracing plan.

Permanent Bracing

Permanent bracing typically includes continuous lateral bracing (CLB),

diagonal bracing, bridging and blocking at the heels and ends of the trusses.

This bracing functions to strengthen and stabilize the truss chords and webs which may be particularly long or highly stressed. The required locations of the continuous lateral bracing are typically called out on the shop drawings supplied by the truss engineering company. These lateral braces must be stabilized at regular intervals with diagonal bracing. This extremely important bracing system creates the continuous path through which all loads applied to the roof are transferred, from the truss system into the walls and eventually to the ground.

Because of the component nature of our fast track building process, permanent bracing design is not supplied by the wall panel designer, or by the truss fabricator, because neither party controls the design process of the other component. To bridge this gap in the information process, a number of engineering firms are beginning to provide permanent bracing design based on their review of the wall and truss layouts supplied by separate parties.

Alpine Structural Consultants

A division of Alpine Engineered Products, Alpine Structural Consultants, is an engineering group that can assist with the design of an entire roof or floor system by providing:

- Roof and floor diaphragm design
- Layout and design of trusses
- Engineered bracing systems for permanent and temporary truss bracing
- Truss-to-Truss and Truss-to-Bearing connections
- Non-truss framing in trussed roof structures, including engineered wood products
- Complete truss system framing plans, including design of stick framing members such as:
 - Fascia beams
 - Headers
 - Blocking
 - Over-framing
 - End wall gable frames

For information regarding the services of Alpine Structural Consultants, for cold-formed steel and wood construction projects, contact: 800-755-6001 or e-mail: info@alpinestructural.net

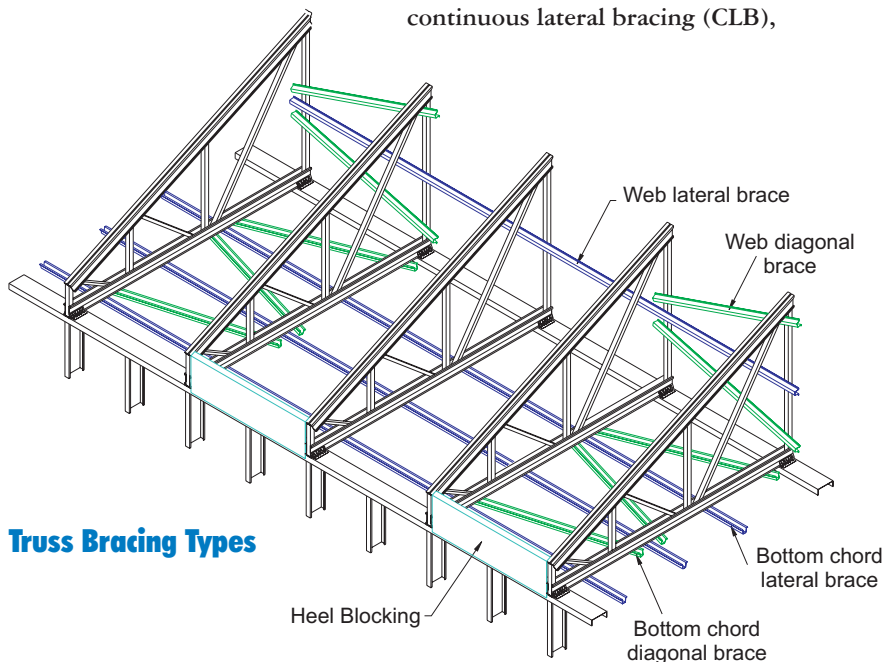

Truss Bracing Types



Storage of Materials During Installation

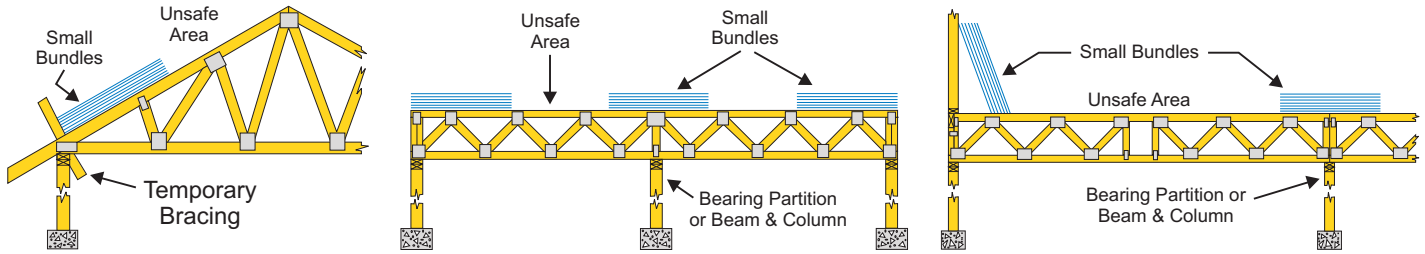

Mechanical Equipment

Platform Stringers Perpendicular To Trusses

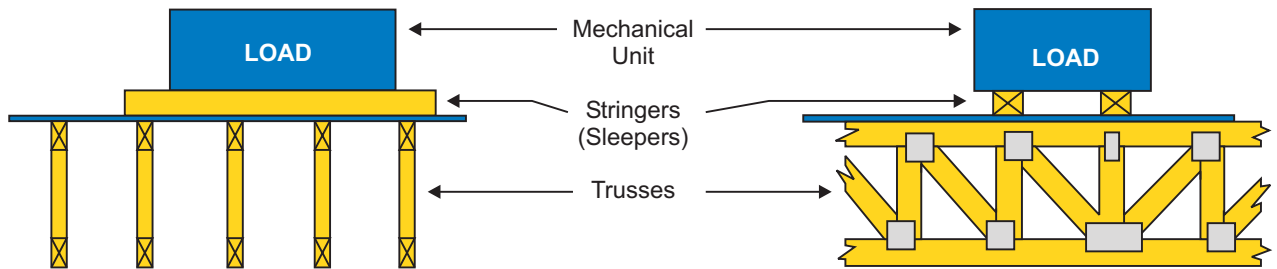

Trusses under mechanical units must be specifically designed and may be doubled. Stringers (sleepers) shall be placed directly over truss joints or a scab of the same size, grade and species of lumber as the top chord shall be nailed to the top chord @ 6" o.c. Scab

shall cover joints on each side adjacent to the stringers (sleepers). If building designer is relying on the sheathing to support the mechanical load or other heavy load, it is important that the building designer verify the sheathing thickness and capability.

Platform Stringers Parallel To Trusses

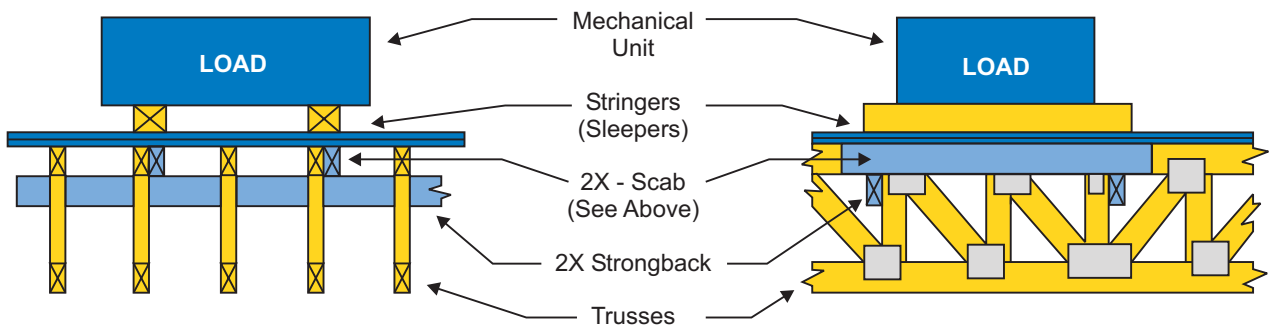

Loads Suspended From Bottom Chords

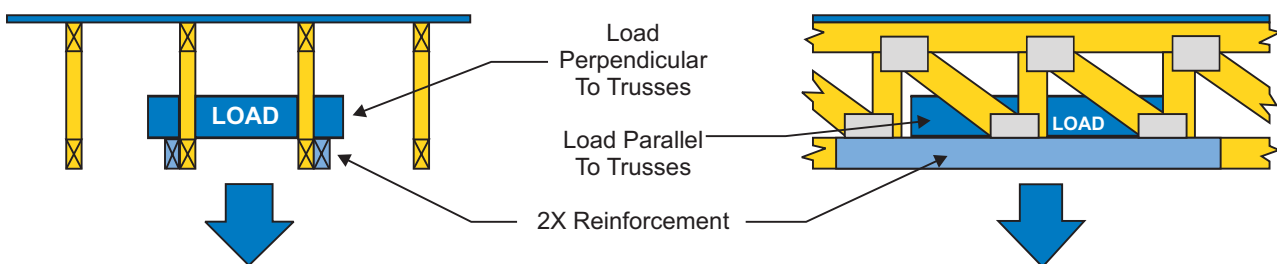

When the load is perpendicular to trusses, reinforcement of bottom chord as well as other parts of truss may be necessary. When the load is parallel to trusses, reinforcement of bottom chord may be necessary.

NOTE: Mechanical loads may produce sufficient vibration to be considered in the truss design. Such loads may require additional trusses or custom design.

Hanger and Connection Installation Information

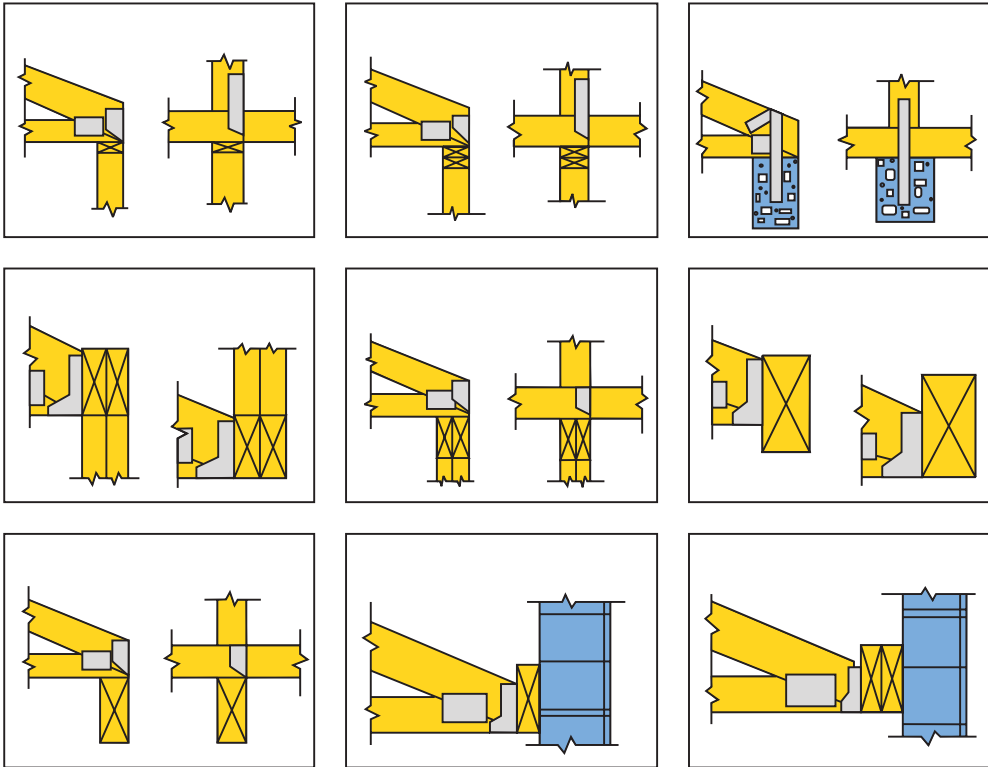

Installation Notes:

- All specified fasteners must be installed according to the instructions in the catalog. Incorrect fastener quantity, size, type, or material may cause the connector to perform poorly or even fail.
- All nails shown in the tables are to be common nails unless noted otherwise. Box nails or sinkers of the same nominal size (length) are not to be used unless an appropriate reduction in the hanger capacity has been made in accordance with the 2001 edition of the *National Design Specification (NDS)* published by the American Forest and Paper Association.
- When special short nails are indicated in the tables, use only nails that have the same diameter as the listed common nail size.
 - An 8d x 1 1/2" nail is 0.131 inch in diameter and 1 1/2" long.
 - A 10d x 1 1/2" nail is 0.148 inch in diameter and 1 1/2" long.
- Do not use any other nails than those shown in the design load tables. If a smaller diameter nail or a shorter nail is used, the listed design load may have to be reduced in accordance with the 2001 NDS.
- The proper installation of structural hangers is dependent on the wood being sound and virtually unchecked in a continuously dry environment. If the wood splits during nailing, it will not support the listed load safely. The wood member should be replaced.
- Unless specified by a professional engineer, lag bolts should not be used with any product listed in the product guide.
- Bolt holes shall be a minimum of 1/32" and a maximum of 1/16" larger than the bolt diameter, per the 2001 NDS.
- When attaching a product to concrete or masonry, the product should be installed plumb, square and true. If necessary, temporarily brace the product in place while the concrete is poured and cured.
- If power or pneumatic nail drivers are used, the nail should be driven through the pre-punched holes only. Use the correct quantity and size of fasteners. The pneumatically driven nails shall conform to the nail sizes shown on the schedules. When using powder actuated or pneumatic nail drivers, always follow the specific written instructions for the equipment and wear safety glasses. Improper use of the nail driving equipment may cause injury to others.
- When prefabricated structural wood is framed into a hanger or other product, follow the manufacturer's written instructions regarding nailing, minimum and maximum nail size, nail locations and the use of blocking or web stiffeners, if required.
- Welding galvanized steel may produce harmful fumes. Please follow proper welding procedures.

Do Not Use Roofing Nails Or Shingle Nails In Hangers At Any Time.

Use The Exact Nails Specified For The Hanger.

For additional information about connectors hangers and hardware, visit Simpson's Website:
<http://www.strongtie.com>



TrusSteel®

The Most Trusted Name in CFS Trusses

Unmatched strength and stiffness in a cold-formed steel truss.

TrusSteel is the most accepted, most specified cold-formed steel (CFS) truss system on the market today. No other building component combines strength, stiffness, fire resistance, insect resistance and design flexibility so well.

The unique, patented truss chord shape and Double-Shear™ fasteners, combined with commercial-grade closed tube webs, make TrusSteel CFS trusses, pound-for-pound, the strongest and

stiffest cold-formed light gauge steel trusses on the market. Not surprisingly, these same characteristics combine to create a light, economical steel building component having exceptional load-span capabilities, with clear spans in excess of 80 ft.

Supported by Alpine's powerful VIEW® design and analysis software, TrusSteel CFS trusses provide reliable, economical structural solutions for almost every roof or floor application.

Contractor-Friendly Installation

Safer to Handle

Unique features of TrusSteel trusses make them safe to handle and erect. Stiffer trusses add handling control and reduce the danger of buckling during lifting and placement. The rolled edges of the chords and webs help protect workers from cuts.

Easier to Install

TrusSteel trusses can be as light as one-half the weight of similar wood or "C" channel steel trusses. Unlike some other CFS trusses, laterally stiff TrusSteel trusses resist folding or "butterflying". And TrusSteel trusses work exceptionally well in rafted installations.

No Special Tools Required

The tools you are now using to erect light gauge steel framing are all you need to install TrusSteel trusses. A full line of TrusSteel construction hardware allows you to make connections with standard screws. Installation details and construction hardware are available from your Authorized TrusSteel Fabricator.

Reduced Callbacks

TrusSteel trusses reduce callbacks because they start straighter and remain straighter than many other types of trusses. And the dimensional stability of steel reduces drywall fastener pops.

Save Time, Effort and Money

TrusSteel trusses streamline the building cycle and save money.

- Timely quotations from local TrusSteel Authorized Fabricators provide competitive prices and define project costs up front.
- Greater price stability with CFS trusses.
- Sealed engineering drawings and code-compliant components expedite submittals.
- Quicker turn-arounds for revisions.
- Delivered to the site ready to erect, shop-built trusses save days of labor.
- Faster truss erection with accurate layouts, extensive details, and a full line of installation hardware.
- Easier site inspections with comprehensive shop drawings and clearly identified components.

Delivered Quality

Roof lines plane accurately, eaves and soffits align properly, and interior ceiling lines are flat and true. High-quality TrusSteel trusses help you achieve your quality goals.

Delivered Value

From bidding to punch list, TrusSteel delivers value to your project through increased safety, quality, efficiency and cost-effectiveness.



TrusSteel®

The Most Trusted Name in CFS Trusses

Proven Benefits

- Outstanding design flexibility

TrusSteel CFS trusses provide the same span capabilities and design flexibilities as wood trusses. And, the pre-engineered system allows much greater design flexibility than steel "C" truss framing. As a result, you can design in familiar roof lines – pitched or flat, with hips, gables, gambrels, monos, mansards, cantilevers, overhangs, scissors – and floor trusses. This design flexibility makes TrusSteel trusses ideal for almost any building type – new construction, retrofit, commercial, institutional, military, educational, industrial and municipal structures.

- Easy to specify and design

There is a wealth of information available to help you specify and design with TrusSteel. A guide specification in CSI format, and standard details in DXF and DWG formats, can assure that your specs and construction documents are accurate and complete. ICBO, NER and UL reports are available to assist you in making design decisions and in working with code officials. Local TrusSteel fabricators can aid you in making informed decisions about project designs and costs.

- Responsible products

TrusSteel CFS trusses contribute to a safe built environment. They do not emit moisture or fumes during their life cycle. They are resistant to insect attack, and do not provide a medium for the growth of mold. And over 64% of the steel used for CFS framing is recycled steel.

- Recognized fire resistance

Noncombustible TrusSteel trusses provide integral, recognized fire resistance that does not fade with time. See page 4 for a list of TrusSteel's useful, cost-saving UL-listed roof and floor assemblies.

- Assured structural performance

With over 35 years of experience in the truss industry, you can rest assured that Alpine understands the structural performance of trusses. The powerful VIEW truss design software analyzes each truss individually using the latest industry standards, guided by the new ANSI/AISI/COFS/TRUSS 2000 - Standard for Cold-Formed Steel Framing - Truss Design. Finally, each truss design is reviewed and sealed by an Alpine Professional Engineer.

- Quality trusses

TrusSteel CFS trusses are built in a shop environment with experienced fabrication personnel. TrusSteel endorses industry truss shop quality control standards as developed by the Steel Truss & Component Association.

- Economical system

Since TrusSteel CFS trusses are the stiffest trusses in the industry, less permanent bracing is typically required in the truss system. This feature, combined with excellent performance at 4 ft. on-center spacings or greater, can reduce the cost of an installed truss system through reduced materials and project downtime. Property insurance premium discounts provide long-term savings.

- Nationwide availability

TrusSteel supports the largest network of independent CFS truss fabricators in the industry. This nationwide network ensures that TrusSteel trusses are available for projects in every region of the United States.



Project Phoenix, the Pentagon rebuild



TrusSteel design information, including Guide Specifications, ICBO & NER reports, UL listed assembly information and extensive Standard Details in CAD formats is available on an interactive CD as well as on www.TrusSteel.com. To order the interactive CD, send an e-mail to info@TrusSteel.net, or call 888-565-9181, and ask for the TrusSteel Cold-Formed Steel Truss Design Guide CD.



Standard Details

JACK HANGER DETAIL

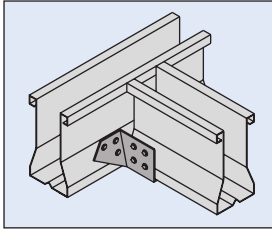

Bottom chord bearing jack to girder truss (rated).

UPLIFT ATTACHMENT TO STEEL

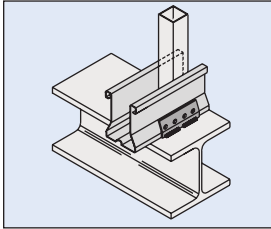

Bottom chord bearing truss to steel girder connection (rated).

UPLIFT ATTACHMENT TO STEEL

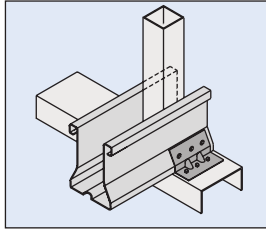

Bottom chord bearing truss to header channel connection (rated).

45° JACK HANGER

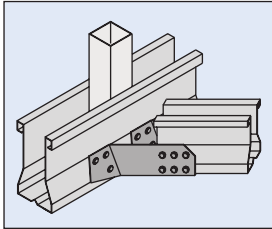

Bottom chord bearing jack truss to girder truss connection (rated).

SPRINKLER PIPE HANGER

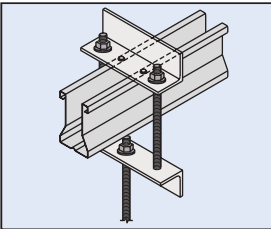

Truss bottom chord hanger detail (rated).

SPRINKLER PIPE HANGER

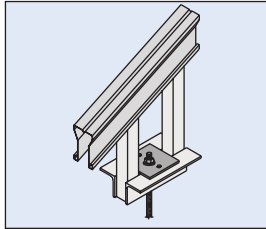

Truss top chord hanger detail (rated).

TrusSteel Connectors

An extensive set of TrusSteel connectors and application details allows a designer to create a complete truss framing system, whatever the roof type, supporting conditions or other framing materials.

All TrusSteel connectors are load-rated connectors, and you can have their performance data at your fingertips with our fully-noted Standard Details (simplified examples shown here).

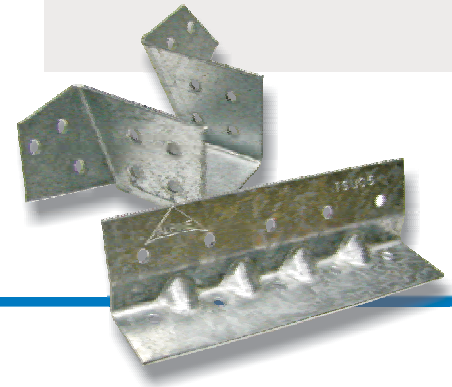

Code Recognition

TrusSteel trusses are designed and built in compliance with ASTM A370, ASTM A653, ASTM A500, ANSI Standards, and voluntary standards as set out in our own reports from the National Evaluation Service (NER 529),

the International Council of Building Officials (ER-5638) and Underwriters Laboratories. Visit our Web site to download the complete reports.

UL Listings

TrusSteel products qualify for hourly ratings as shown below.

Design Number	Assy. Type	Hourly Rating	Material Assembly
No. P515 (pitched)	R	1	Double layer 5/8" Type C Gypsum Board
No. P525 (pitched)	R	1, 1-1/2, 2	Single layer 5/8" Type C Gypsum Board
	U	1, 1-1/2	Single layer 5/8" Type C Gypsum Board
	U	2	Double layer 5/8" Type C Gypsum Board
No. P526 (pitched)	R,U	1	Single layer 5/8" Type C Gypsum Board with insulation in cavity
No. L551 (flat / floor)	U	1	Single layer 5/8" Type C Gypsum Board with insulation in cavity
No. G542 (flat / floor)	R,U	1	Single layer 5/8" Type C Gypsum Board with insulation in cavity

Notes

R = Restrained Assembly
U = Unrestrained Assembly

Typical Roof Truss Design Spans



Every TrusSteel roof truss is a custom design based upon the unique load, span, bearing, use, and code criteria of a particular project. The load / span tables shown below demonstrate only a tiny subset of the possible combinations available with TrusSteel CFS roof trusses.

Chord Size	Load 1 20, 10, 10 psf 90 mph wind				Load 2 30, 10, 10 psf 90 mph wind				Load 3 20, 10, 10 psf 140 mph wind				Load 4 30, 10, 10 psf 140 mph wind			
	TSC2.75		TSC4.00		TSC2.75		TSC4.00		TSC2.75		TSC4.00		TSC2.75		TSC4.00	
O.C. Truss Spans	2'	4'	2'	4'	2'	4'	2'	4'	2'	4'	2'	4'	2'	4'	2'	4'
Pitch																
Common																
3/12	48	26	80+	62	38	20	80+	52	48	26	80+	62	38	20	80+	52
4/12	56	31	80+	77	45	23	80+	60	56	31	80+	77	45	23	80+	60
5/12	62	33	80+	80+	52	27	80+	65	62	33	80+	80+	52	27	80+	65
6/12	64	36	80+	80+	55	27	80+	75	64	33	80+	80+	55	27	80+	75
7/12	64	37	80+	80+	56	28	80+	80+	64	35	80+	80+	56	28	80+	80+
8/12	64	38	80+	80+	58	30	80+	80+	64	37	80+	80+	58	30	80+	80+
Scissor																
Pitch																
3/12	27	15	57	32	22	13	48	26	27	15	57	32	22	13	48	26
4/12	34	19	69	43	28	15	65	36	34	19	69	43	28	15	65	36
5/12	40	22	77	51	33	18	69	42	40	22	77	51	33	18	69	42
6/12	46	25	79	57	38	20	72	47	46	25	79	57	38	20	72	47
7/12	50	28	80+	60	44	23	73	53	50	28	80+	60	44	23	73	53
8/12	53	31	80+	61	49	25	74	55	53	31	80+	61	49	25	74	55
Mono																
Pitch																
3/12	36	25	80+	60	32	21	80+	50	36	25	80+	60	32	21	80+	50
4/12	34	26	80+	64	32	23	80+	52	34	26	80+	64	32	23	80+	52
5/12	34	26	80+	64	32	23	80+	52	34	26	80+	64	32	23	80+	52
6/12	34	26	80+	64	32	23	80+	52	34	26	80+	64	32	23	80+	52
7/12	34	28	80+	64	33	23	80+	52	34	28	80+	64	33	23	80+	52
8/12	34	28	80+	64	33	23	80+	52	34	28	80+	64	33	23	80+	52
Flat																
Depth																
12"	22	18	24	20	19	16	24	20	22	18	24	20	19	16	24	20
18"	30	23	36	28	29	21	33	27	30	23	36	28	29	21	33	27
24"	39	28	45	35	35	25	42	32	39	28	45	35	35	25	42	32
36"	49	35	64	46	44	28	59	41	49	35	64	46	44	28	59	41
48"	58	36	75	55	51	29	70	49	58	36	75	55	51	29	70	49
60"	65	36	80+	62	57	29	80	55	65	36	80+	62	57	29	80	55
72"	66	33	80+	68	51	25	80+	61	66	33	80+	68	51	25	80+	61



General Notes:

- Spans shown in charts are in feet.
- Loads shown above are outlined as Top Chord Live Load (TCLL), Top Chord Dead Load (TCDL), and Bottom Chord Dead Load (BCDL).
- Top chord designed assuming structural sheathing offers lateral restraint.
- Bottom chords designed assuming lateral restraint spaced at 24 inches on center.
- Deflection limits: Live Load - L/360 Total Load - L/240
- Trusses designed with ASCE7-98 wind
 - Wind speed shown in charts
 - Exposure C
 - Building category II
 - Truss bearing elevation is 8'0"
 - No topographic effect from escarpment or hill taken into account
 - Enclosed building
- Some trusses above may require a piggyback truss due to excessive truss height.
- 80+ as shown above means that a span in excess of 80'0" is possible. Refer to TrusSteel Technical Bulletin TB991102 and a TrusSteel engineer regarding these spans.
- Scissor trusses designed with a bottom chord pitch equal to half of the top chord pitch i.e. a 6/12 top chord pitch scissor truss will have a 3/12 bottom chord pitch.
- Designs may include multiple gauges for top and bottom chords as determined by the designer using Alpine's VIEW engineering software. Maximum chord gauges are 18 gauge for the TSC2.75 chord and 16 gauge for the TSC4.00 chord.
- The truss web pattern used in the design is to be determined by the designer using Alpine's VIEW engineering software.

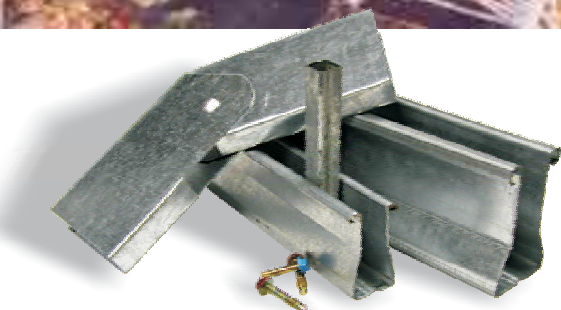



Evolution of Metal Plate Connected Wood Trusses

The highly engineered metal plate connected wood truss as we know it today is the evolution from a principle known to building designers for centuries. Architectural trussing was a late Roman invention, although it didn't really become popular until the early Gothic period in Northern France around 1100. Church construction began to feature pointed arches and vaults, and an overall feeling of height. The latter was not always just an impression - some ceilings towered 150 feet above the faithful.

By the 15th century, Leonardo Da Vinci's notebooks contained numerous drawings and comments about the strengths of framing members arranged in triangular configurations.

The practice of binding, or connecting, structural members in triangular configurations results in a product known as a truss. Prior to the 1940's most trusses in the building industry were constructed of heavy steel. The use of wood as members was primarily limited to timbers with bolted connections in large buildings and bridges.

The early days of World War II created a demand for the hurried construction of a large amount of military housing. To satisfy this demand, engineers in many cases chose dimensional lumber, connected with glued and nailed plywood gussets, or

simply nailed joints, to form "wood trusses" to speed the jobsite time for framing roofs.

This practice was continued following the end of the war to fulfill a pent-up demand for single family housing.

To shorten the labor intensive process of cutting the plywood gussets and glue/nailing them to the dimensional lumber, a light gauge metal plate was devised. The early plates were predrilled to receive nails - still somewhat labor intensive, but an improvement.

Looking to reduce the labor and increase truss production, Carol Sanford invented a light gauge metal plate with "teeth" punched from the base metal. These plates could then be imbedded into the lumber by a mechanical device. His metal connector became a forerunner of today's modern, highly engineered and tested quality connector.

Lumber used in manufacturing trusses has also changed drastically. In the early days, ordinary construction lumber was used. Much of the lumber now used in trusses is machine stress rated or visually graded lumber whose stress rating is based on rules established by years of testing. The reliability of lumber today is more predictable.

Adding to these improvements are the methods used to cut and assemble the wooden members of the truss. Widespread use of saws with computer controlled angle and length settings assure more accurate fitting of pieces and joints than with older hand set saws. Computer aided controls are also used to set the jiggling points during the truss assembly and manufacturing process, further assuring more accurate fit of members and joints.

The wood truss is now a highly engineered product utilizing two excellent materials; wood, an energy efficient, renewable resource and steel, a recyclable resource.



Vave
r Plate

The Industry

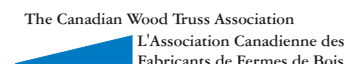

The metal plate connected wood truss industry is represented by two trade associations. In the U.S.A., connector plate manufacturers are organized in an association known as the Truss Plate Institute (TPI), and the truss manufacturers association is named the Wood Truss Council of America (WTCA). Both organizations are located in Madison, Wisconsin.

TPI is responsible for developing and publishing the design and testing methodology for wood trusses and is accredited by the American National Standards Institute (ANSI) as a consensus based standards writing organization. A listing of the standards and recommended practices of TPI is contained in Appendix B. WTCA, is an association of wood truss manufacturers, and works closely with TPI on many projects. WTCA promotes

high standards in the manufacture and delivery of trusses by its member firms and is active in the marketing of and education about trusses. WTCA publishes the *Metal Plate Connected Wood Truss Handbook*, a complete guide to the design, manufacturing and use of wood trusses and other publications (see Appendix B). WTCA produces educational video presentations to train in the proper installation of trusses. WTCA and TPI is the voice of the industry in government and code matters.

In Canada, the metal plate connected wood truss industry is similarly represented by two trade associations. The Truss Plate Institute of Canada (TPIC) and The Canadian Wood Truss Association (CWTA).

Wood Truss Handbook

For technical design and additional information about wood trusses, the Wood Truss Council of America (WTCA) publishes the *Metal Plate Connected Wood Truss Handbook*. The publication contains more than 300 pages of references regarding the truss manufacturing industry. It is considered the most comprehensive reference of its kind in the industry.

The Handbook covers the A-to-Z of information about wood trusses.

Contact:

Wood Truss Council of America, 5937 Meadowood Drive, Suite 14, Madison, WI 53711-4125
Phone: 608/274-4849, Fax: 608/274-3329

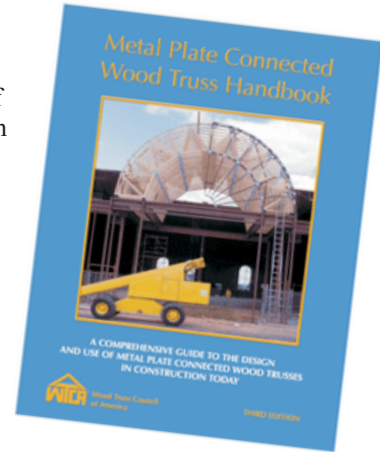

Internet Web Site

Alpine maintains a site on the Internet's world wide web that provides additional reference material and links to hundreds of pages of useful information about trusses and other products. The entire Construction Hardware Division's catalog is there, as well as full specifications and information about FR-Systems Fire Resistance Assemblies. Please visit that site for additional information, parts of this publication, or just for browsing. You can find us at the following URL: <http://www.alpeng.com>

<http://www.alpeng.com>



Video Training

Alpine makes available, through truss manufacturers who use their products and services, a number of video productions that are great for use in training new employees or in safety meetings.

Some of the subjects available are:

- *Lifting Wood Trusses by Crane*
- *Handling, Installing and Bracing of Metal Plate Connected Wood Trusses*

Your truss manufacturer also has available video presentations for loan that are produced by the Wood Truss Council of America.

- *MPC Trusses: Fire Performance, Tactics and Strategy*
- *Bracing and Erecting Wood Trusses*
- *Building With Floor Trusses*

Contact your local truss manufacturer for additional information.





Types Of Stresses To Be Considered In The Design Of Trusses

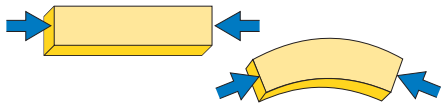

Compressive Stress Parallel To Grain

Truss top chords are generally in compression. When subjected to compressive stress, wood members can buckle. The longer and more slender the member is, the less compressive force it takes to buckle. In lumber, the compressive strength is measured by the F_c value.

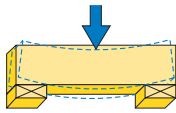

Bending

Bending occurs between supports when lumber is subjected to loads. Bending strength is measured by the F_b value of the lumber.

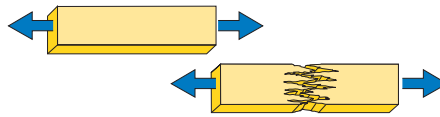

Tensile Stress

When subjected to tensile stress, wood members can elongate. Truss bottom chords are normally in tension. In lumber, tension strength is measured by the F_t value.

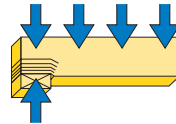

Compressive Stress Perpendicular To Grain

An example of compression perpendicular to grain is the bottom chord sitting on a support. It is necessary that the bottom chord lumber area be sufficient to prevent side grain crushing. Lumber's resistance to crushing is rated by the $F_{c\perp}$ value.



Horizontal Shear

Horizontal shear occurs along the grain, causing fibers to slide over each other. In lumber, horizontal shear strength is measured by the F_v value.

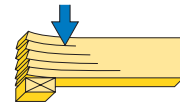

Vertical Shear

An example of vertical shear occurs at the inside of the truss support. Wood is stronger in vertical shear than horizontal shear. Since a vertical shearing force produces both vertical and horizontal shear stresses, wood will fail in horizontal shear instead of vertical shear.

Loads In Wood Trusses

This truss illustrates the action of the various stresses occurring along the wood members.

The applied loads induce stresses and movement in the truss members. A stable truss will resist these stresses.

The wood members are designed to resist the stress according to the allowable design values published in the National Design Specification For Wood Construction (NDS). NDS is published by the National Forest Products Association.

Forces at the member joints are resisted by metal connector plates that are held in place by "teeth" punched out of the base metal at right angles. The plates are rated for lateral resistance (tooth holding), shear, and tension and require review and approval by each of the model codes.

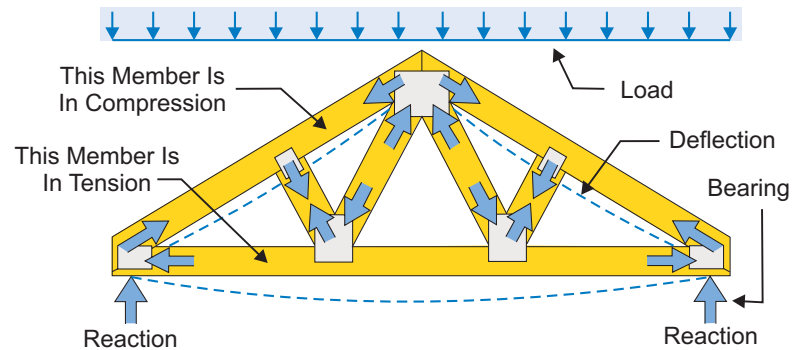

Short Term Loading

Wood has the ability of carrying a greater load for short durations than for long durations.

Duration Of Load Adjustment

The table shows the more common types of loads, their expected accumulated duration and the factor of adjustment in the allowable lumber stresses and the lateral resistance value (tooth holding) of the connector plate. Note: the factors do not apply to shear and tension in the connector plate, nor do they apply to E and $F_{c\perp}$. See NDS Section 2.3 for possible exceptions.

Load Type	Duration Of Load	Adjustment Factor
Dead Load	Permanent	.90
Floor Live - Normal	10 Years	1.00
Snow Load	2 Months	1.15
Construction	7 Days	1.25
Wind/Earthquake Load*	10 Minutes	1.60
Impact	Impact	2.00

* 1.33 in some codes

Other Adjustments

Other adjustments to design values may be necessary. Consult NDS Chapter 2. The value of lumber in extreme fiber bending " F_b " may be increased when there are three or more trusses spaced not more than 24 inches on center and are joined by load-distributing elements.

In special single-member applications where deflection may be a critical factor, or where deformation must be limited, reduction of modulus of elasticity (E) value may be appropriate.

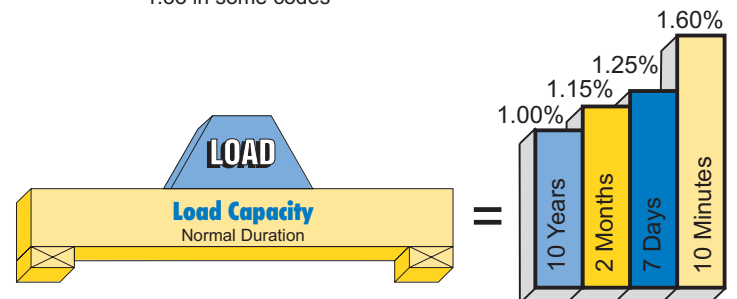

All weights are pounds per square foot (psf) unless otherwise shown.

DECKING AND INSULATION

3/8 inch thick Plywood / OSB	1.2
1/2 inch thick Plywood / OSB	1.7
5/8 inch thick Plywood / OSB	2.1
3/4 inch thick plywood / OSB	2.5
1-1/8 inch thick plywood / OSB	3.6
1 inch nominal wood.	2.3
2 inch nominal wood decking	4.3
16 ga. Corrugated Steel	2.5
20 ga. Corrugated Steel	1.8
22 ga. Corrugated Steel	1.5
24 ga. Corrugated Steel	1.3
28 ga. Corrugated Steel	1.0
Rigid Fiberglass - 1 inch thick.	1.5
Styrofoam - 1 inch thick.	0.2
Insulrock - 1 inch thick.	2.7
Poured gypsum - 1 inch thick.	6.5
Rock Wool - per 1 inch of thickness	0.4
Glass Wool - per 1 inch of thickness	0.2
Vermiculite - per 1 inch of thickness	2.6

WALLS AND PARTITIONS

Masonry, per 4 inches of thickness:	
Brick	38.0
Concrete Block	30.0
Stucco - 7/8 inch thick	10.0
2x4 Framing @ 16" oc with 1/2 inch Thick gypsum each side	6.0
2x6 Framing @ 16" oc with 1/2 inch Thick gypsum each side.	7.0

CEILINGS

1/2 inch thick Gypsum board	2.2
5/8 inch thick Gypsum board	2.8
5/8 inch thick Type X Gypsum bd	3.0
Acoustical Fiber Tile	1.0
Metal Grid Ceiling	0.8
Plaster - 1 inch thick.	8.0
Plaster on Metal Lath	8.5

ROOFING

Asphalt Shingles - Minimum (1 Layer)	2.5
Clay Tile Shingles	12.0
1/4 inch Slate Shingles	10.0
Wood Shakes - 5/8 inch thick	3.0
3 Ply & Gravel	5.6
4 Ply & Gravel	6.0
5 Ply & Gravel	6.5

FLOORING

Hardwood - 1 inch nominal	4.0
Quarry Tile 3/4 inch thick	10.0
Linoleum or Soft Tile	1.5
Vinyl Tile - 1/8 inch thick.	1.4
Concrete:	
Reinforced 1 1/2 inch thick.	17.5
Lightweight 1 1/2 inch thick	12.5
Terrazzo 1 1/2 inch thick	19.0

LUMBER (32 pcf)

Nominal Size:	@ 12" oc	@ 16" oc	@ 24" oc
2x4	1.4	1.1	0.7
2x6	2.2	1.7	1.1
2x8	2.9	2.2	1.5
2x10	3.7	2.8	1.9
2x12	4.4	3.3	2.2

WOOD TRUSSES - (APPROXIMATE)

Based on Southern Pine			
Top Chord	Bottom Chord	PLF	24" oc.
2x4	2x4	5.2	2.6
2x6	2x4	6.1	3.1
2x6	2x6	6.9	3.5
2x8	2x6	7.8	3.9
2x8	2x8	8.5	4.3
2x10	2x8	9.3	4.7
2x10	2x10	10.1	5.2
2x12	2x10	10.9	5.5
2x12	2x12	11.6	5.8

We suggest the addition of 1.5 psf for misc. dead loads

FLOOR TRUSSES - (APPROXIMATE)

Based on Southern Pine		
All members 2x4 - Weights are PLF		
Depth in inches	Single Chord	Double Chord
12	5.0	
14	5.25	
16	5.5	8.4
18	5.75	8.6
20		8.9
24		9.4

SPRINKLER SYSTEMS

Pipe Size	Dry (PLF)	Wet (PLF)
1	1.7	2.1
1 1/4	2.3	3.0
1 1/2	2.7	3.6
2	3.7	5.2
2 1/2	5.8	7.9
3	7.6	10.8
3 1/2	9.2	13.5
4	10.9	16.4
5	14.8	23.5
6	19.2	31.7
8	28.6	50.8

NOTE: The weight of wood and wood products will vary as the moisture content varies and as density of grain varies. Code of jurisdiction should be consulted for live load requirements. Weight of manufactured products should be verified with manufacturers.

Appendix B -- References

The materials listed below provide a good resource library for the design and use of wood trusses. Please contact the publisher/group directly for further information.

American Forest & Paper Association (AFPA) 202/463-2700
1111 19th St. NW, # 700 • Washington, DC 20036 www.afandpa.org
• *National Design Specification for Wood Construction (NDS)*
• *Wood Frame Construction Manual*

American National Standards Institute (ANSI) 212/642-4900
11 West 47th Street • New York, NY 10036 web.ansi.org
• *See TPI*

APA - The Engineered Wood Association 206/565-6600
1119 A Street • Tacoma, WA 98401 www.apa.wood.org
• *Use of Rated Sheathing in Roofs and Floors*
• *Fire Rated Systems*
• *Diaphragm Design*

American Society of Civil Engineers (ASCE) www.asce.org
1801 Alexander Bell Dr. • Reston, VA 20191-4400
• *Minimum Design Loads for Buildings And Other Structures, ASCE7*

American Society for Testing and Materials (ASTM) www.astm.org
1916 Rice Street • Philadelphia, PA 19103
• *Test Methods for Fire Tests for Building Construction and Materials, E-119*

Building Officials and Code Administrators International, Inc. (BOCA) 708/799-2300
4051 W. Flossmoor Road • Country Club Hills, IL 60478 www.bocaresearch.com
• *The BOCA National Building Code*

Council of American Building Officials (CABO) 703/931-4533
5203 Leesburg Pike, Suite 798 • Falls Church, VA 22041 www.cabo.org
• *One and Two Family Dwelling Code*

Forest Products Laboratory www.fpl.fs.fed.us
U.S. Department of Agriculture
One Gifford Pinchot Drive • Madison, WI 53705
• *Wood Handbook: Wood as an Engineered Material*

Gypsum Association 202/289-5440
810 First St. NE, # 510 • Washington, DC 20002 www.gypsum.org
• *Fire Resistance Design Manual, GA-600*

International Code Council (ICC) 703-931-4533
5203 Leesburg Pike, #600 • Falls Church, VA 22041 www.intlcode.org
• *International Building Code*
• *International Residential Code*

International Conference of Building Officials (ICBO) 213/699-0541
5360 S. Workman Mill Rd • Whittier, CA 90601 www.icbo.com
• *Uniform Building Code*
• *Uniform Fire Code*

NAHB Research Center 301-249-4000
400 Prince Georges Blvd. • Upper Marlboro, MD 20774 www.nahbrc.org

National Frame Builders Association (NFBA) 913/843-2111
4980 W. 15th St., # 1000 • Lawrence, KS 66049 www.postframe.org
• *Post Frame Building Design*
• *Post Frame Comes of Age*
• *Recommended Practices-Post Frame Construction*

Southern Forest Products Association (SFPA) 504/443-4464
P. O. Box 641700 • Kenner, LA 70064 www.southernpine.com
• *Southern Pine Maximum Spans for Joists and Rafters*
• *Southern Pine Use Guide*

Southern Building Code Congress International, Inc. (SBCCI) 205/591-1853
900 Montclair Road • Birmingham, AL 35213-1206 www.sbcci.org
• *Standard Building Code*
• *Wind Design Standard, SSTD 10-93*

Truss Plate Institute (TPI) 608/833-5900
583 D'Onofrio Drive, Suite 200 • Madison, WI 53719 www.tpinst.org
• *National Design Standard for Metal Plate Connected Wood Truss Construction, ANSI/TPI 1-2002*
• *Standard for Testing Metal Plate Connected Wood Trusses, ANSI/TPI 2-1995*
• *Recommended Design Specification for Temporary Bracing of MPC Wood Trusses, DSB-89*
• *Handling, Installation and Bracing Metal Plate Connected Wood Trusses, HIB-91*

Western Wood Products Association (WWPA) 503/224-3930
533 SW Fifth Ave. • Portland, OR 97204 www.wwpa.org
• *Western Lumber Product Use Manual*

Wood Truss Council of America 608/274-4849
One WTCA Center www.woodtruss.com
6300 Enterprise Ln. • Madison, WI 53719
• *Metal Plate Connected Wood Truss Handbook*
• *Job-Site Bracing Poster - TTB Series*
• *ANSI/TPI/WTCA 4-2002*

Canadian References

Alpine Systems Corporation 905/879-0700
70 Moyal Court • Concord, ON L4K 4R8 www.alpeng.com
• *Truss Design Procedures and Specifications for Light Metal Plate Connected Wood Trusses (Limit States Design), published by TPIC*

Canadian Wood Truss Association - L'Association Canadienne des Fabricants de Fermes de Bois 613/747-5544
1400 Blair Place, Suite 210 • Ottawa, ON K1J 9B8 www.cwc.ca
• *Wood Design Manual*

Canadian Standards Association 416/747-4044
178 Rexdale Boulevard • Rexdale, ON M9W 1R3 www.csa.ca
• *CSA 086.194 "Engineering Design in Wood (Limit States Design)"*
• *CSA S347-M1980 "Method of Test for Evaluation of Truss Plates Used in Lumber Joints"*

National Research Council of Canada Institute for Research in Construction 613/993-2463
1500 Montreal Road • Ottawa, ON K1A 9Z9 www.nrc.ca/irc
• *National Building Code of Canada (NBCC)*
• *National Farm Building Code of Canada (NFBCC)*

AXIAL FORCE - A push (compression) or pull (tension) acting along the length of a member. Usually measured in pounds (lbs).

AXIAL STRESS - The axial force acting along the length of a member, divided by the cross-sectional area of the member. Usually measured in pounds per square inch (psi).

BEARING - Structural support of a truss, usually walls, hangers or posts.

BENDING MOMENT - A measure of the bending effect on a member due to forces acting perpendicular to the length of the member. The bending moment at the given point along a member equals the sum of all perpendicular forces, either to the left or right of the point, times their corresponding distances from the point. Usually measured in inch-pounds.

BENDING STRESS - The force per square inch acting at a point along the length of a member, resulting from the bending moment applied at that point. Usually measured in pounds per square inch (psi).

BOTTOM CHORD - A horizontal or inclined (scissors truss) member that establishes the lower edge of a truss, usually carrying combined tension and bending stresses.

BRACING - See Lateral Bracing

BUILT-UP BEAM - A single unit composed of two or more wood members having the same thickness but not necessarily the same depth, which provides a greater load carrying capacity as well as greater resistance to deflection.

BUTT - CUT - Slight vertical cut at outside end of truss bottom chord made to insure uniform nominal span and tight joints. Usually 1/4-inch.

CAMBER - An upward vertical displacement built into a truss, usually to offset deflection due to dead load.

CANTILEVER - The part of a structural member that extends beyond its support.

CLEAR SPAN - Horizontal distance between interior edges of supports.

COMBINED STRESS - The combination of axial and bending stresses acting on a member simultaneously, such as occurs in the top chord (compression + bending) or bottom chord (tension + bending) of a truss.

CONCENTRATED LOAD - An additional load centered at a given point. An example is a crane or hoist hanging from the bottom chord at a panel point or mechanical equipment supported by the top chord.

DEAD LOAD - Permanent loads that are constantly on the truss, ie: the weight of the truss itself, purlins, sheathing, roofing, ceiling, etc.

DEFLECTION - Downward or horizontal displacement of a truss due to loads.

DIAPHRAGM - A large, thin structural element that acts as a horizontal beam to resist lateral forces on a building.

DRAG STRUT - Typically a horizontal member, such as a truss or beam, that transfers shear from a diaphragm to a shearwall.

DURATION OF LOAD FACTOR - An adjustment in the allowable stress in a wood member, based on the duration of the load causing the stress. The shorter the time duration of the load, the higher the percentage increase in allowable stress.

HEEL - Point on a truss at which the top and bottom chord intersect at the end of a truss with a sloping top chord.

LATERAL BRACING - A member installed and connected at right angles to a chord or web member of a truss to resist lateral movement.

LEVEL RETURN - Lumber filler placed horizontally from the end of an overhang to the outside wall to form soffit framing.

LIVE LOAD - Any load which is not of permanent nature, such as snow, wind, seismic, movable concentrated loads, furniture, etc. Live loads are generally of short duration.

NOMINAL SPAN - Horizontal distance between outside edges of the outermost supports.

OVERHANG - The extension of the top chord (usually) or bottom chord of a truss beyond the support.

PANEL - The chord segment defined by two successive joints.

PANEL LENGTH - The centerline distance between joints measured along the chord.

PANEL POINT - The centerline of the point of intersection in a joint where a web(s) meets a chord.

PEAK - Point on a truss where the sloped top chords meet.

PLUMB CUT - Top chord cut that is plumb to the building floor line provided for vertical installation of a fascia.

PURLIN - A horizontal member in a roof perpendicular to the truss top chord used to support the decking.

REACTION - Forces acting on a truss through its supports that are equal but opposite to the sum of the dead and live loads.

SHEARWALL - A wall element that acts as a large vertical beam, cantilevered from the foundation to resist lateral forces on the building.

SLOPE (Pitch) - The inches of vertical rise in 12 inches of horizontal run for inclined members, generally expressed as 3/12, 4/12 etc.

SPLICE POINT (Top or Bottom Chord Splice) - The point at which two chord members are joined together to form a single member.

SQUARE CUT - A cut perpendicular to the slope of the member at its end.

TOP CHORD - An inclined or horizontal member that establishes the upper edge of a truss, usually carrying combined compression and bending stresses.

TRUSS - A pre-built component that functions as a structural support member. A truss employs one or more triangles in its construction.

VIBRATION - The term associated with the serviceability of a floor. If the occupant feels the floor respond to walking or other input, it may be referred to as vibration or response to load.

WEBS - Members that join the top and bottom chords to form the triangular patterns that give truss action, usually carrying tension or compression stresses (no bending).

Truss Production Sequence



Computer Design Workstation



Automated Sawing



Computer Aided Jigging For Lumber



Connector Plate Placement



Truss Pressing



Job Staging



Delivery



Erection



Professional Truss Support Coast to Coast



www.alpeng.com

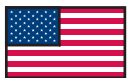

Alpine Engineered Products, Inc.

Florida: Home Office • P.O. Box 2225 • Pompano Beach, FL 33061 • 954-781-3333
1950 Marley Drive • Haines City, FL 33844 • 941-422-8685

Texas: 2820 N. Great Southwest Parkway • Grand Prairie, TX 75050 • 972-660-4422

Missouri: 13389 Lakefront Drive • Earth City, MO 63045 • 314-344-9121

Illinois: 825 S. Industrial Drive • Litchfield, IL 62056 • 217-324-0303

California: 8351 Rovana Circle • Sacramento, CA 95828 • 916-387-0116



Alpine Systems Corporation

Ontario: 70 Moyal Court • Concord, ON L4K 4R8 • 905-879-0700

Québec: 2 Place de Commerce, Suite 207 • Brossard, PQ J4W 2T8 • 514-923-5555

British Columbia: 2922 Glen Drive, #204 • Coquitlam, BC V3B 2P5 • 604-944-4100

